

SIGNED DRAWINGS MUST ACCOMPANY PURCHASE ORDER OR DIMENSIONS OF FITTINGS WILL NOT BE GUARANTEED

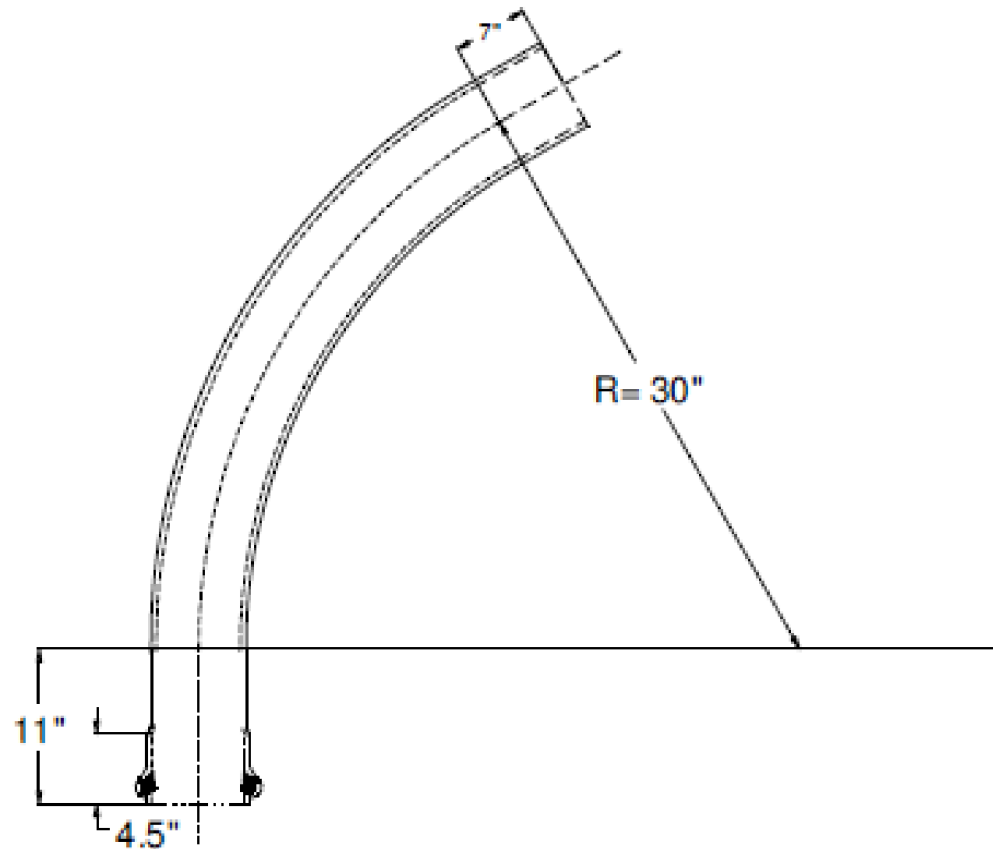

DISCLAIMER - PLEASE READ

- DUE TO VARIOUS FACTORS AFFECTING PRODUCTION, ALL DIMENSIONS ARE APPROXIMATE
- DIMENSIONS AND APPEARANCE ARE SUBJECT TO CHANGE WITHOUT NOTICE DUE TO DESIGN OR PRODUCTION MONIFICATIONS
- ANGLE TOLERANCE FOR ELBOWS IS +/- 2 DEGREES.
- ALL OTHER DIMENSIONS ARE TO TOLERANCES OF +/- 1"
- ALL FITTINGS ARE SUBJECT TO P.T.I. "STANDARD TERMS AND CONDITIONS"

**6" 1/8 BEND (45) (EXTRA LONG SWEEP RADIUS)
SDR35 GASKETED SEWER
6"x6" SxG**

ROYAL Building Products

56400 Mound Road, Shelby Township, MI 48316
Phone (586)781-2700 Fax (586)781-0888

PRINTED COPIES ARE FOR REFERENCE ONLY

DATE: 5/21/2014 DRAWN BY: BCS

DATE: 5/21/2014 CHECKED BY: RBP

L4906.S

CUSTOMER