

SIGNED DRAWINGS MUST ACCOMPANY PURCHASE ORDER OR DIMENSIONS OF FITTINGS WILL NOT BE GUARANTEED

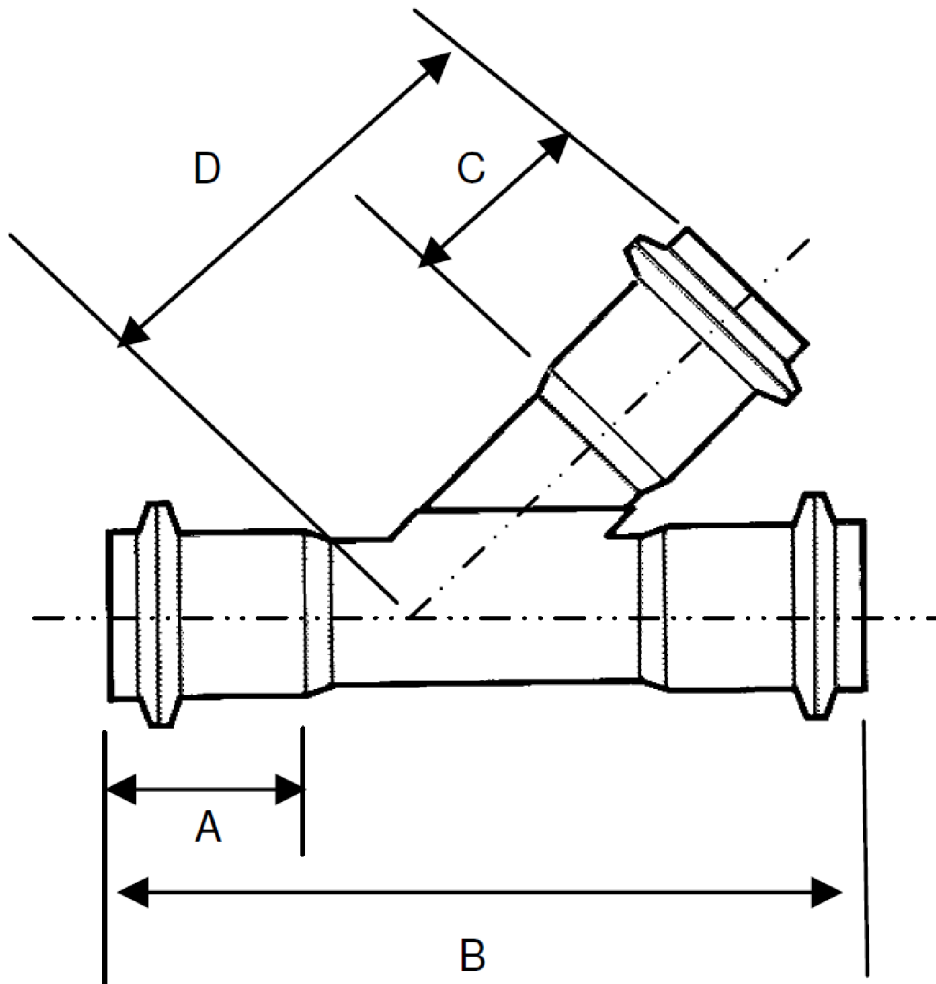

SIZE	30X6	30X12	30X24
A	19.5	19.5	19.5
B	62.5	72.5	91.5
C	4.5	6.5	12.5
D	33.25	39.5	51.5

DISCLAIMER - PLEASE READ

- DIMENSIONS AND APPEARANCE ARE APPROXIMATE AND SUBJECT TO CHANGE WITHOUT NOTICE DUE TO DESIGN OR PRODUCTION MODIFICATIONS
- ANGLE TOLERANCE FOR ELBOWS IS +/- 2 DEGREES.
- ALL OTHER DIMENSIONS ARE TO TOLERANCES OF +/- 1"
- ALL FITTINGS ARE SUBJECT TO RBP "STANDARD TERMS AND CONDITIONS"

**30" 45° WYE
PVC SDR35 GASKETED SEWER
30" x 6" GxGxG**

ROYAL[™] Building Products
royalbuildingproducts.com

56400 Mound Road, Shelby Township, MI 48316
Phone (800)232-5690 -- Fax (586)781-0888

PRINTED COPIES ARE FOR REFERENCE ONLY

DATE: 5/27/2015 DRAWN BY: RKS

DATE: 5/27/2015 CHECKED BY: RBP

L3030-6.S

CUSTOMER