

6" TRADE SIZE
SDR35 SEWER
GASKET HUB

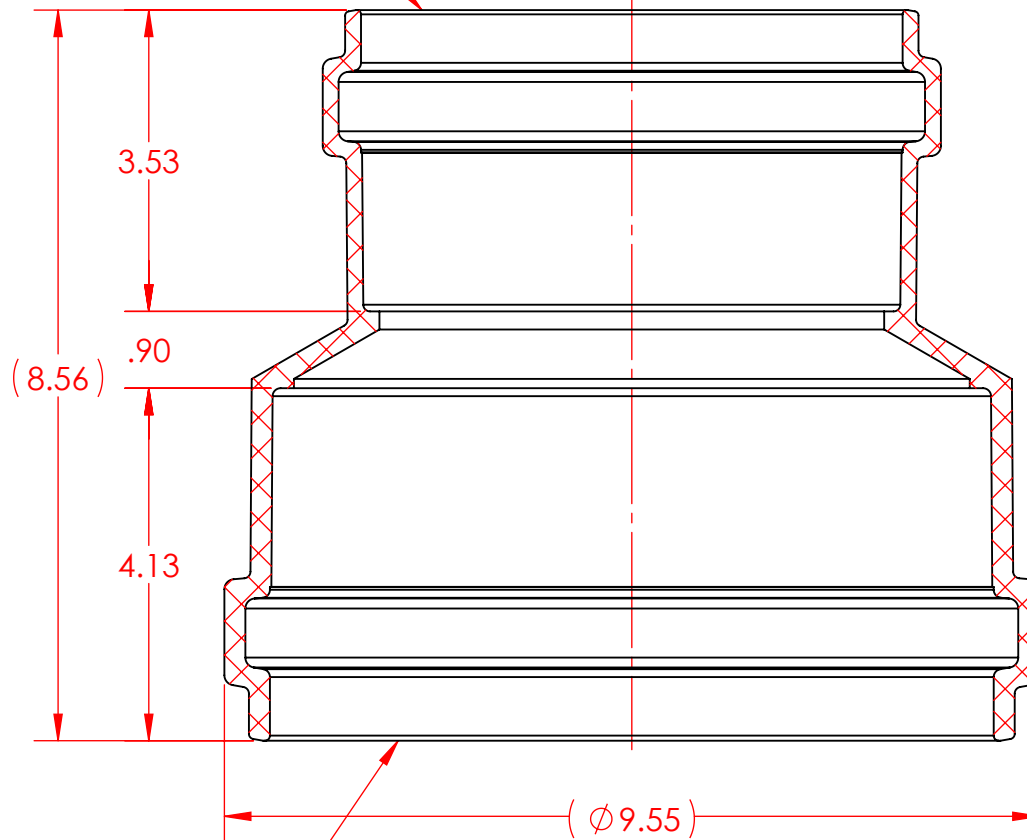

8" TRADE SIZE
SDR35 SEWER
GASKET HUB

GASKETS NOT SHOWN

REF.
CSA B182.2
ASTM D3034

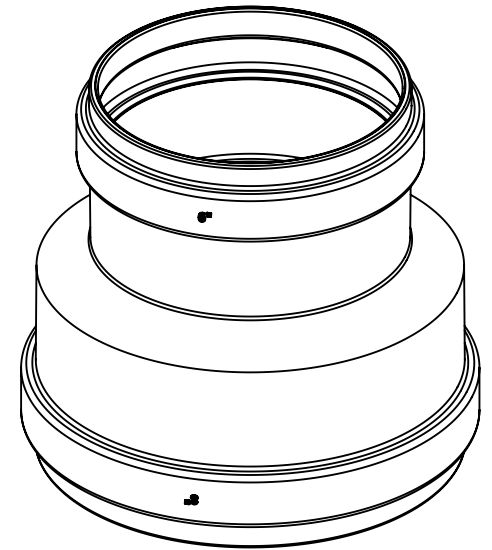

**8" CONCENTRIC INCREASER COUPLING
PVC SDR35 GASKETED SEWER**

8" x 6" GxG

NAPCO PIPE & FITTINGS

56400 Mound Road
Shelby Township, MI 48316
U.S.A.
Phone (800) 232-5690 | Fax (586) 781-0888
CSshelby@napcopipe.com | www.napcopipe.com

REFERENCE ONLY

FILE NAME:

G608-6.D02