

SIGNED DRAWINGS MUST ACCOMPANY PURCHASE ORDER OR DIMENSIONS OF FITTINGS WILL NOT BE GUARANTEED

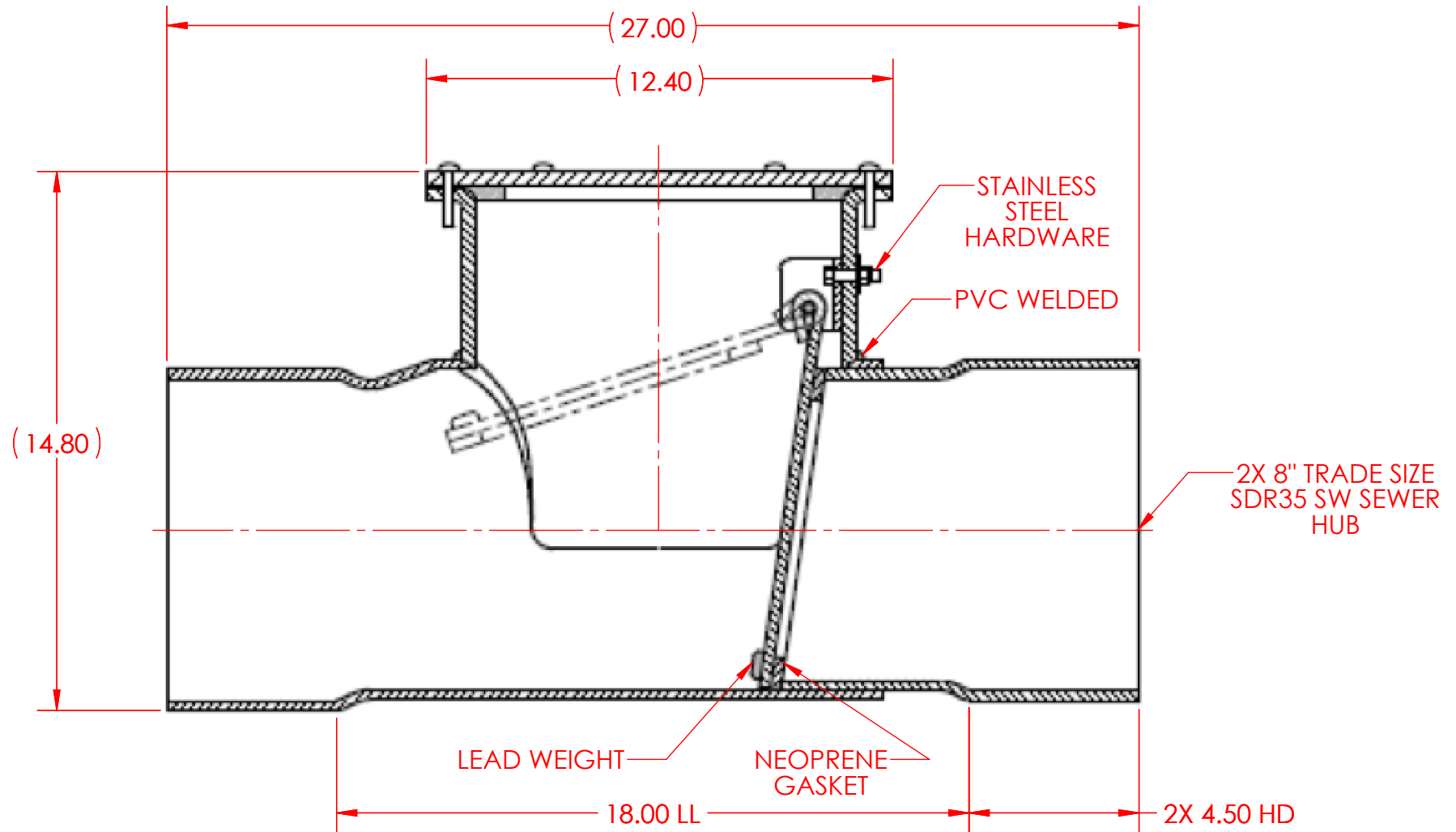

DISCLAIMER - PLEASE READ

- DIMENSIONS AND APPEARANCE ARE APPROXIMATE AND SUBJECT TO CHANGE WITHOUT NOTICE DUE TO DESIGN OR PRODUCTION MODIFICATIONS
- ANGLE TOLERANCE IS +/- 2 DEGREES.
- ALL OTHER DIMENSIONS ARE TO TOLERANCES OF +/- 1"
- ALL FITTINGS ARE SUBJECT TO NAPCO "STANDARD TERMS AND CONDITIONS"

REF.
79ABWV08
79ABWV--SPEC

NAPCO PIPE & FITTINGS

56400 Mound Road
Shelby Township, MI 48316
U.S.A.
Phone (800) 232-5690 | Fax (586) 781-0888
CSShelby@napcopipe.com | www.napcopipe.com

8" IN-LINE BACKWATER VALVE
PVC SDR35 SW SEWER
8"x 8" HxH

PRINTED COPIES ARE FOR REFERENCE ONLY

DATE: 10/3/2019 DRAWN BY: GEB
DATE: 10/3/2019 CHECKED BY: NAPCO

P0108.L

CUSTOMER