



D2241 Certa-Lok® Fittings

NAPCO produces Expansion Couplings, Tapped Couplings, Adapters, and Sweeps directly compatible with our D2241 Certa-Lok pipe products.

For additional appurtenance needs, consult the full Yelomine Brochure. Additionally, our D2241 Certa-Lok pipe products can be mated to compatible Iron Pipe Size (IPS) third-party fittings.

Notes:

1. These dimensions are for estimating purposes only. All dimensions are in inches unless otherwise specified.
2. ASTM Pressure Rating @ 73°F and includes 2:1 safety factor.
3. Expansion couplings do not provide a fully restrained joint.
4. Non-permanent gaskets are typically used in temporary bypass applications that require disassembly and reuse of the joint. They should never be specified for permanent, buried, or submerged applications. Permanent gaskets are slightly larger and make disassembly of the joint more difficult. They are intended for all installations that do not require disassembly during the system's service life including buried installation, river and road crossings, and all installations that would expose joints to long-term or excessive misalignment due to external loads. If in doubt as to which gasket should be chosen, consult your NAPCO Sales Representative or Technical Services Group.

Short Form Specification	
Pipe Standard:	ASTM D2241
Diameter Std.:	Iron Pipe Size (IPS)
Nominal Sizes:	2", 3", 4", 6", 8", 10", 12", 14", 16"
Color:	Yellow
Fitting Compound:	ASTM D1784 Cell Class 12454 with Yelomine® Technology
Pipe Joint Std.:	Gasketed – ASTM D3139 Solvent Weld – ASTM D2672
Gasket Standard:	ASTM F477
Certifications:	NSF 61
Installation Std.:	AWWA D2774

* Certa-Lok Sweeps are made from D2241/RJ pipe that additionally meets NSF 14.



Only products bearing the NSF Mark are Certified

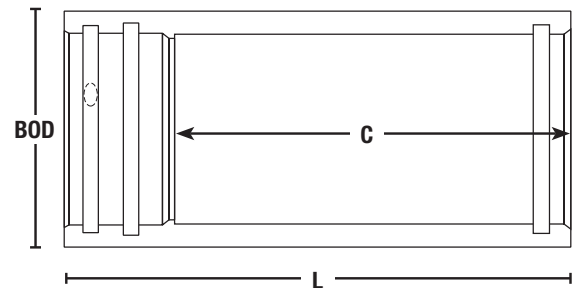

D2241 CERTA-LOK YELOMINE EXPANSION COUPLINGS CERTA-LOK FEMALE X GASKETED SLIP JOINT

Nom. Size	Pipe Outside Diameter	Pressure Rating (psi)	Certa-Lok Groove Compatibility		BOD	L	C	Weight (lb)	Part Number			
			D2241/RJ	D2241/RJIB					Permanent Use			Splines
									Fitting*	Certa-Lok Gasket	Slip Joint Gasket	
2"	2.375	250	Yes	N/A	3.200	18.000	15.075	3.2	82157716423	OR020YMPI	GSP2000200	S0210RN0
3"	3.500	250	Yes	N/A	4.380	18.000	14.075	4.9	82157716430	OR030YMPI	GSP2000300	S0316RN0
4"	4.500	250	Yes	Yes	5.470	18.000	13.575	6.8	82157010536	OR040YMPI	GSP2V20400	S4518RN0
6"	6.625	250	Yes**	Yes	7.840	18.000	13.575	12.4	82157010537	OR060YMPI	GSP2V20600	S0624RN0
8"	8.625	250	Yes**	Yes	10.190	18.000	12.688	20.8	82157010538	OR080YMPI	GSP2V20800	S0832SN1
10"	10.750	200	Yes	N/A	12.438	18.000	11.325	27.7	82157010539	OR100YMPI	GSP2V21000	S1039SN0
12"	12.750	200	Yes	N/A	16.648	18.000	11.325	36.9	82157010540	OR120YMPI	GSP2V21200	S1246TN0
16"	16.000	90	Yes	N/A	17.400	18.000	11.500	33.7	8215771653	OR160YMPI	OR160YMPI	S1656TN0

* Includes permanent style gaskets and splines

** Not compatible with D2241/RJ DR 12.43 pipe



MUNICIPAL PRODUCT SPECIFICATION

D2241 Certa-Lok® Fittings

D2241 CERTA-LOK YELOMINE SWEEPS CERTA-LOK MALE X CERTA-LOK MALE									
Nom. Size	Pressure Rating (psi)	Certa-Lok Groove Compatibility		OD	Angle (deg)	L	W	Weight (lb)	Part Number
		D2241/RJ	D2241/RJIB						
2"	250	Yes	N/A	2.375	22.5	17.340	3.449	1.4	82157710780
					45	18.108	7.501	1.7	82157710834
					90	16.703	16.703	2.4	82157710889
3"	250	Yes	N/A	3.500	22.5	26.022	5.176	4.4	82157710797
					45	25.974	10.759	4.8	82157710841
					90	23.146	23.146	6.8	82157710896
4"	250	Yes	Yes	4.500	22.5	26.048	5.181	7.9	82157710803
					45	28.727	11.899	9.6	82157710858
					90	30.273	30.273	15.8	82157710902
6"	250	Yes**	Yes	6.625	22.5	28.962	5.761	17.6	82157710810
					45	39.181	16.229	26.4	82157710865
					90	42.007	42.007	44.1	82157710919
8"	250	Yes**	Yes	8.625	22.5	43.393	8.631	44.7	82157710827
					45	52.003	21.540	59.8	82157710872
					90	46.614	46.614	83.8	82157710926
10"	200	Yes	N/A	10.750	22.5	69.417	13.808	63.6	82157705236
					45	72.874	30.185	74.3	82157705250
					90	71.367	71.367	114.5	82157705267
12"	200	Yes	N/A	12.750	22.5	69.427	13.810	89.5	82157705243
					45	72.947	30.216	104.5	82157705274
					90	71.796	71.796	161.0	82157705281
16"	200	Yes	N/A	16.000	22.5	83.876	16.684	171.0	82157706424
					45	85.897	35.580	194.8	82157706448
					90	78.655	78.655	277.9	82157706462

** Not compatible with D2241/RJ DR 12.43 pipe

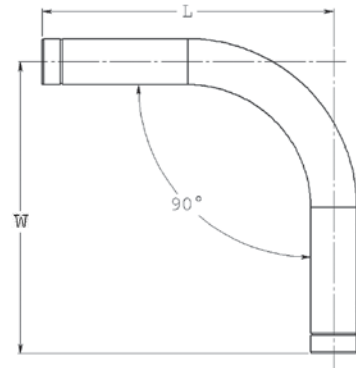
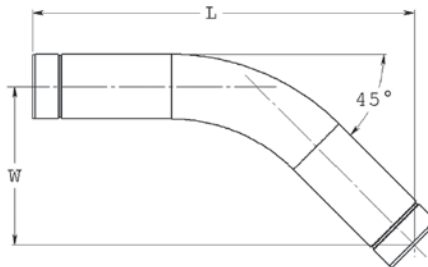
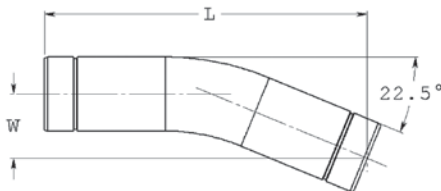



D2241 Certa-Lok® Fittings

D2241 CERTA-LOK® YELOMINE® SOLVENT WELD CIOD NIPPLE ADAPTER CERTA-LOK® MALE X CIOD SOLVENT WELD MALE								
Nom. Size	D2241 CL YM Outside Diameter, OD ₁	CIOD Pipe Outside Diameter, OD ₂	Pressure Rating (psi)	Certa-Lok Groove Compatibility		L	Weight (lb)	Part Number
				D2241/RJ	D2241/RJIB			
4"	4.500	4.800	250	Yes	Yes	10.000	2.6	82157708855
6"	6.625	6.900	250	Yes**	Yes	12.000	6.3	82157708862
8"	8.625	9.050	250	Yes**	Yes	13.500	12.5	82157708879
10"	10.750	11.100	200	Yes	N/A	16.000	21.5	82157707810
12"	12.750	13.200	200	Yes	N/A	16.000	23.0	82157707827

** Not compatible with D2241/RJ DR 12.43 pipe

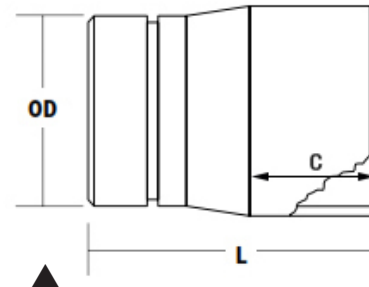
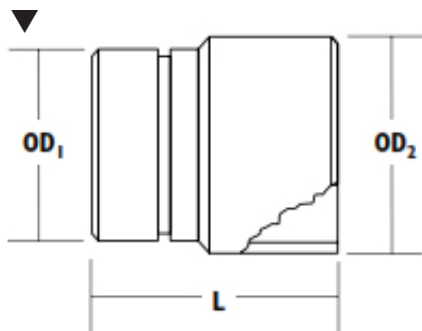

D2241 CERTA-LOK® YELOMINE® SOLVENT WELD IPS ADAPTERS CERTA-LOK® MALE X IPS SOLVENT WELD FEMALE								
Nom. Size	Pipe Outside Diameter	Pressure Rating (psi)	Certa-Lok Groove Compatibility		L	C	Weight (lb)	Part Number
			D2241/RJ	D2241/RJIB				
2"	4.500	250	Yes	N/A	6.625	2.750	0.5	82157705304
3"	6.625	250	Yes	N/A	8.625	3.875	1.4	82157705311
4"	4.500	250	Yes	Yes	9.250	4.375	2.3	82157705328
		315	Yes	Yes	9.250	4.375	6.1	82157706493
6"	6.625	250	Yes**	Yes	11.375	4.500	5.3	82157705335
		315	Yes**	Yes	11.375	4.500	10.7	82157706509
8"	8.625	250	Yes**	Yes	12.875	4.500	9.0	82157705342
		315	Yes**	Yes	12.875	4.500	18.6	82157706516
10"	10.750	200	Yes	N/A	15.250	6.000	11.0	82157705168
12"	12.750	200	Yes	N/A	15.250	6.000	15.0	82157705175

** Not compatible with D2241/RJ DR 12.43 pipe





D2241 Certa-Lok® Fittings

D2241 CERTA-LOK® YELOMINE® SOLVENT WELD IPS ADAPTERS CERTA-LOK® FEMALE X IPS SOLVENT WELD FEMALE													
Nom. Size	Pipe Outside Diameter	Pressure Rating (psi)	Certa-Lok Groove Compatibility		BOD	L	C	Weight (lb)	Part Number				
			D2241 RJ	D2241 RJIB					Permanent Use		Non-Permanent Use		Spline
									Fitting*	Gasket	Fitting*	Gasket	
2"	2.375	250	Yes	N/A	3.200	5.500	2.475	1.0	82157715358	OR020YMPI	82157705359	OR020YMNN	S0210RN0
3"	3.500	250	Yes	N/A	4.380	8.000	3.600	2.3	82157715365	OR030YMPI	82157705366	OR030YMNN	S0316RN0
4"	4.500	250	Yes	Yes	5.470	9.000	4.100	3.6	82157715372	OR040YMPI	82157705373	OR040YMNN	S4518RN0
		350	Yes	Yes	5.964	9.000	4.100	5.6	82157010557	OR040YMPI	-	-	S0418SN0
6"	6.625	250	Yes**	Yes	7.840	9.000	4.100	6.4	82157715389	OR060YMPI	82157705380	OR060YMNN	S0624RN0
		315	Yes**	Yes	8.366	11.250	6.100	11.9	82157010558	OR060YMPI	-	-	S0624RN0
		350	Yes‡	No	9.050	11.000	6.100	16.9	82157010559	OR060YMPI	-	-	S0624TN0
8"	8.625	250	Yes**	Yes	10.190	10.125	4.600	12.0	82157715396	OR080YMPI	82157705397	OR080YMNI	S0832SN1
		315	Yes**	Yes	10.947	11.750	6.100	21.5	82157010560	OR080YMPI	-	-	S0832SN1
		350	Yes‡	No	10.947	11.750	6.100	21.6	82157010561	OR080YMPI	-	-	S0832TN2
10"	10.750	200	Yes	N/A	12.438	12.125	5.850	19.3	82157715082	OR100YMPI	82157705083	OR100YMNI	S1039SN0
12"	12.750	200	Yes	N/A	14.648	12.125	5.850	25.5	82157715099	OR120YMPI	82157705090	OR120YMNI	S1246TN0
16"	16.000	90	Yes	N/A	17.400	12.125	5.850	23.0	82157715136	OR160YMPI	82157705212	OR160YMNI	S1656TN0

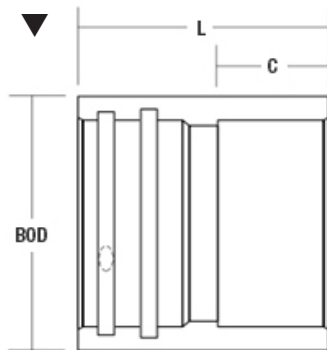

* Includes permanent or non-permanent style gasket as applicable and spline

** Not compatible with D2241/RJ DR 12.43 pipe

‡ Only compatible with D2241 Certa-Lok DR 12.43 pipe





D2241 Certa-Lok® Fittings

D2241 CERTA-LOK® YELOMINE® TAPPED COUPLINGS CERTA-LOK® FEMALE X CERTA-LOK® FEMALE X NPT TAPPED HOLE											
Nom. Size	Pipe Outside Diameter	Tapped Hole Size	Pressure Rating (psi)	Certa-Lok Groove Compatibility		BOD	L	Weight (lb)	Part Number		
				D2241 RJ	D2241 RJIB				Non-Permanent Use		Spline
									Fitting*	Gasket	
2"	2.375	3/4" NPT	200	Yes	N/A	3.200	7.000	1.3	82157705403	OR020YMNN	S021ORNO
		1" NPT	200	Yes	N/A	3.200	7.000	1.3	82157705441		
3"	3.500	3/4" NPT	200	Yes	N/A	4.380	9.500	2.7	82157705410	OR030YMNN	S0316RNO
		1" NPT	200	Yes	N/A	4.380	9.500	2.7	82157705458		
		1-1/2" NPT	160	Yes	N/A	4.380	9.500	2.7	82157705465		
4"	4.500	1/2" NPT	200	Yes	Yes	5.470	10.500	4.2	82157716560	OR040YMNN	S4518RNO
		3/4" NPT	200	Yes	Yes	5.470	10.500	4.2	82157705427		
		1" NPT	200	Yes	Yes	5.470	10.500	4.2	82157705472		
		1-1/2" NPT	200	Yes	Yes	5.470	10.500	4.1	82157705489		
		1-1/2" NPT	250	Yes	Yes	5.964	10.500	6.5	82157706585		
6"	6.625	3/4" NPT	200	Yes**	Yes	7.840	11.250	8.1	82157705434	OR060YMNN	S0624RNO
		1" NPT	200	Yes**	Yes	7.840	11.250	8.1	82157705496		
		1-1/2" NPT	200	Yes**	Yes	7.840	11.250	8.1	82157705502		
		1-1/2" NPT	250	Yes**	Yes	8.366	11.250	11.9	82157706592		
		2" NPT	160	Yes**	Yes	7.840	11.250	8.0	82157705540		
8"	8.625	1" NPT	200	Yes**	Yes	10.190	12.500	15.1	82157705519	OR080YMNI	S0832SN1
		1-1/2" NPT	200	Yes**	Yes	10.190	12.500	15.0	82157705526		
		1-1/2" NPT	250	Yes**	Yes	10.947	12.500	22.9	82157715778		
		2" NPT	160	Yes**	Yes	10.190	12.500	15.0	82157705533		
		3" NPT	130	Yes**	Yes	10.190	13.500	16.1	82157705588		
10"	10.750	1-1/2" NPT	200	Yes	N/A	12.438	15.000	23.8	82157707858	OR100YMNI	S1039SNO
12"	12.750	2" NPT	160	Yes	N/A	14.648	15.000	31.8	82157707803	OR120YMNI	S1246TNO

* Includes non-permanent style gasket and spline
 ** Not compatible with D2241/RJ DR 12.43 pipe

