

# List Price Book Electrical Fittings

Prices Effective March 1, 2020



# LIST PRICE BOOK ELECTRICAL FITTINGS

Prices Effective March 1, 2020

NAPCO injection molded and fabricated fittings are recognized for the highest quality standards in the industry. NAPCO offers fittings with Triple Certification Listing

**Please Note:**

- Parts listed with a single asterisk are injection molded fittings.
- Parts listed with a † are fittings that are fabricated from molded components.
- Parts with no asterisk are fabricated fittings.

**Rigid PVC Conduit Fittings & Accessories (E-Series)**

**E**

E1 - E6

**ENT Fittings (E-Series)**

**E**

E7 - E10

## **POLICY AND TERMS**

### **Claims Policy**

Discrepancy claims must be reported within two business days of receipt of order.

### **Freight Policy**

Freight is prepaid for orders totaling \$1,500 net or greater. Some items are special order and may not qualify for prepaid freight. Prepaid freight applies to a single shipment to one destination within the continental United States.

### **Minimum Order Policy**

A minimum order of \$100 net is required.

### **Non-Stock Product Policy**

Non-stock product is considered special order and is non-cancelable and non-returnable.

### **Standard Payment Terms**

Payment terms are 2% 30 net 45 days.

### **Return Goods Policy**

All returns must be approved by NAPCO Pipe & Fittings and accompanied by a return goods authorization number also issued by NAPCO Pipe & Fittings. A minimum restocking fee of 25% will apply to all returned goods. The shipper is responsible for return freight.

**For the most up to date Terms & Conditions,  
please visit  
<https://napcopipe.com/en/terms-conditions>**

## **E-SERIES RIGID PVC CONDUIT FITTINGS AND ACCESSORIES**

**Injection Molded in Sizes 1/2" - 6"**

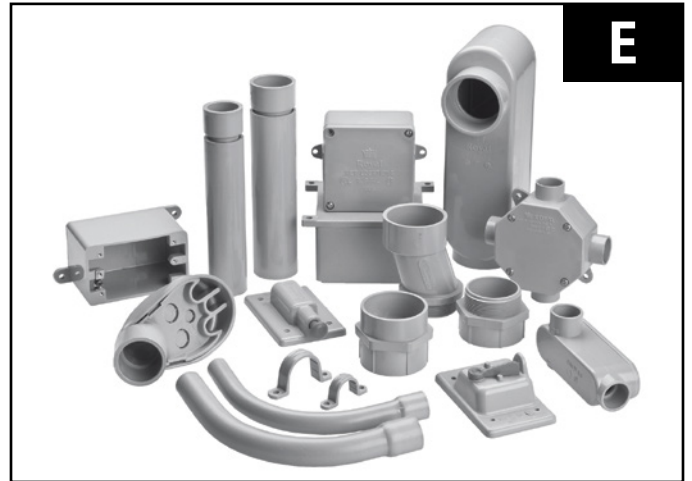

NAPCO offers a complete line of rigid PVC conduit fittings. NAPCO's non-metallic conduit and fittings are certified by the CSA and UL where applicable, for use in above and below ground applications.





NAPCO rigid PVC conduit systems are used in non-burial applications, encased in concrete, concealed in walls and direct burial applications:

- Utilities
- Cable, data and communication lines
- Institutional, commercial, industrial buildings
- Residential applications, including service entrances
- Street and highway underground feeds
- Transportation systems - subways, bridges, tunnels, airports
- Water and wastewater treatment plants
- Marinas
- Mines and mills

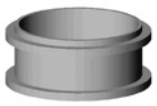
Item	Size In Inches	Part Number	Box Qty	List Price
<b>Coupling HxH</b>				
	1/2	E010050	200	47.29
	3/4	E010075	125	58.36
	1	E010100	70	89.88
	1 1/4	E010125	40	119.85
	1 1/2	E010150	30	167.25
	2	E010200	40	217.68
	2 1/2	E010250	20	383.39
	3	E010300	40	634.08
	3 1/2	E010350	30	701.05
	4	E010400	20	978.09
5	E010500	10	2,475.43	
6	E010600	8	3,164.97	
8	E010800	3	10,360.25	

Item	Size In Inches	Part Number	Box Qty	List Price
<b>Bell End Coupling HxS</b>				
	1/2	E070050	100	560.25
	3/4	E070075	100	622.80
	1	E070100	50	736.55
	1 1/4	E070125	50	899.83
	1 1/2	E070150	50	944.36
	2	E070200	40	1,347.28
	2 1/2	E070250	30	1,459.52
	3	E070300	50	1,570.73
	3 1/2	E070350	50	1,732.03
	4	E070400	50	1,869.94
5	E070500	25	2,942.04	
6	E070600	15	3,226.96	

Item	Size In Inches	Part Number	Box Qty	List Price
<b>Terminal Adapter HxMIPT</b>				
	1/2	E011050	200	62.90
	3/4	E011075	125	111.32
	1	E011100	70	140.44
	1 1/4	E011125	40	180.63
	1 1/2	E011150	30	217.83
	2	E011200	40	313.10
	2 1/2	E011250	20	532.32
	3	E011300	40	779.90
	3 1/2	E011350	30	1,006.72
	4	E011400	20	1,338.64
5	E011500	10	2,634.65	
6	E011600	8	3,167.13	

Item	Size In Inches	Part Number	Box Qty	List Price
<b>Service Entrance Fitting H</b>				
	1/2	E025050	10	1,611.48
	3/4	E025075	10	1,690.20
	1	E025100	20	1,992.15
	1 1/4	E025125	20	2,678.84
	1 1/2	E025150	20	3,235.09
	2	E025200	5	5,386.80
	2 1/2	E025250	5	27,359.90
	3	E025300	5	26,452.89
	3 1/2	E025350	5	74,301.19
	4	E025400	1	81,395.26

Item	Size In Inches	Part Number	Box Qty	List Price
<b>Solvent Weld End Cap H</b>				
	1/2	E026050	100	405.38
	3/4	E026075	100	445.15
	1	E026100	50	506.75
	1 1/4	E026125	25	644.63
	1 1/2	E026150	25	727.66
	2	E026200	50	1,244.41
	2 1/2	E026250	25	2,714.73
	3	E026300	25	2,836.10
	3 1/2	E026350	25	4,332.45
	4	E026400	25	5,909.54
5	E026500	25	6,860.17	
6	E026600	10	7,393.11	
8	E026800	6	39,425.12	

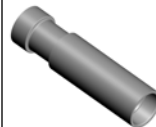

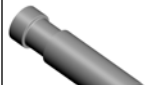

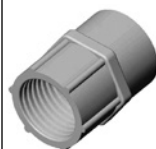

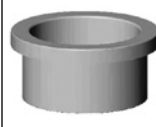
Item	Size In Inches	Part Number	Box Qty	List Price
<b>Expansion Joint Coupling HxH</b>				
	1/2	E016050	25	8,115.30
	3/4	E016075	10	8,413.04
	1	E016100	10	8,365.73
	1 1/4	E016125	5	8,450.59
	1 1/2	E016150	5	8,576.17
	2	E016200	25	9,197.62
	2 1/2	E016250	12	12,756.61
	3	E016300	12	16,147.56
	3 1/2	E016350	6	19,933.26
	4	E016400	6	23,652.28
5	E016500	1	36,182.83	
6	E016600	1	48,933.64	



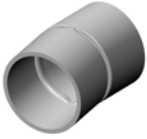
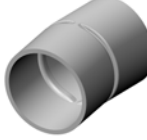

Item	Size In Inches	Part Number	Box Qty	List Price
<b>Expansion Joint w/Terminal Adapter HxFIPT</b>				
	2	E016200TA	4	31,043.08
	2 1/2	E016250TA	8	47,366.39
	3	E016300TA	8	48,444.50
	4	E016400TA	8	72,903.46

Item	Size In Inches	Part Number	Box Qty	List Price
<b>Female Adapter (NPT Tapered Thread) HxFIPT</b>				
	1/2	E012050	200	71.60
	3/4	E012075	125	118.58
	1	E012100	70	160.33
	1 1/4	E012125	40	214.49
	1 1/2	E012150	30	228.09
	2	E012200	40	310.68
	2 1/2	E012250	20	689.37
	3	E012300	40	860.26
	3 1/2	E012350	30	1,125.72
	4	E012400	20	1,153.41
5	E012500	10	2,868.80	
6	E012600	8	3,787.09	

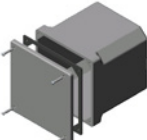
Item	Size In Inches	Part Number	Box Qty	List Price
<b>Junction Box Adapters HxFlange</b>				
	1/2	E059050	100	261.87
	3/4	E059075	100	259.88
	1	E059100	100	281.32
	1 1/4	E059125	50	300.68
	1 1/2	E059150	50	307.19
	2	E059200	25	336.96
	2 1/2	E059250	10	1,395.70
	3	E059300	10	1,402.45
	3 1/2	E059350	10	1,539.62
	4	E059400	10	1,614.95

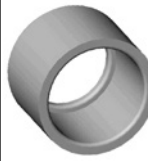
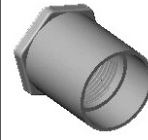
• List Price per 100 Units  
• Tested and Listed by CSA and UL

Item	Size In Inches	Part Number	Box Qty	List Price
<b>5 Degree Coupling HxH</b>				
	2	E013200	20	4,975.36
	2 1/2	E013250	12	4,811.87
	3	E013300	25	5,699.36
	3 1/2	E013350	15	6,044.74
	4	E013400	15	6,287.29
	5	E013500	8	7,459.81
	6	E013600	4	10,381.65
<b>5 Degree Coupling SxH</b>				
	2	E013200S	20	4,975.36
	2 1/2	E013250S	12	4,811.87
	3	E013300S	25	5,699.36
	3 1/2	E013350S	15	6,044.74
	4	E013400S	15	6,287.29
	5	E013500S	8	7,459.81
	6	E013600S	4	10,381.65
<b>Universal Plug w/Pull Tab Polyethylene</b>				
	2	E091200	70	481.51
	3	E091300	45	709.24
	4	E091400	80	748.99
	5	E091500	45	1,000.35
	6	E091600	35	1,238.51
<b>Strain Relief Connector</b>				
	3/4	E030075	25	3,476.66
<b>Pull Elbow HxH</b>				
	1/2	E027050	75	1,993.03
	3/4	E027075	50	2,206.23
<b>Meter Offset HxMIPT</b>				
	1 1/4	E024125	15	2,240.69
	2	E024200	8	2,385.90
<b>Octagonal Box with Cover and Knockout Plugs</b>				
	1 1/2 (4)	E028150	20	4,274.94
	2 (4)	E028200	12	4,377.68
<b>Octagonal Box Extension Ring</b>				
	1	E029100	20	1,592.08
	2	E029200	20	1,863.25
<b>Junction Box with Gasket (Self-Tapping Screws)</b>				
	4 x 4 x 2	E051442	10	3,214.37
	4 x 4 x 4	E051444	10	5,302.40
	4 x 4 x 6	E051446	10	6,020.75
	5 x 5 x 2	E051552	10	6,367.86
	6 x 6 x 4	E051664	10	6,491.09
	6 x 6 x 6	E051666	5	7,574.36
	8 x 8 x 4	E051884	5	12,246.44
	8 x 8 x 7	E051887	4	18,040.65
	12 x 12 x 4	E05112124	2	18,520.73
	12 x 12 x 6	E05112126	2	19,142.58
	12 x 12 x 8	E05112128	3	29,544.29

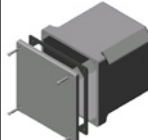
Item	Size In Inches	Part Number	Box Qty	List Price
<b>Reducer Bushing SxH</b>				
	3/4 x 1/2	E0140705	100	322.23
	1 x 1/2	E0141005	300 †	726.63
	1 x 3/4	E0141007	100	742.74
	1 1/4 x 3/4	E0141207	50 ^	952.06
	1 1/4 x 1	E0141210	50	966.88
	1 1/2 x 1	E0141510	50	1,032.84
	1 1/2 x 1 1/4	E0141512	50	984.43
	2 x 1	E0142010	50	1,176.77
	2 x 1 1/4	E0142012	25	1,202.58
	2 x 1 1/2	E0142015	25	1,199.46
	2 1/2 x 2	E0142520	25	3,953.20
	3 x 2	E0143020	25	4,446.13
	3 x 2 1/2	E0143025	25	4,761.67
	4 x 2	E0144020	15	5,245.83
	4 x 3	E0144030	20	5,285.31
4 3/2	E0144035	20	5,638.91	
† = 20/bag    ^ = 5/bag				
<b>Threaded Reducer Bushing SxFIPT</b>				
	3/4 x 1/2	E0150705	200	1,182.38
	1 x 1/2	E0151005	200	1,765.15
	1 x 3/4	E0151007	200	1,421.34
<b>Threaded Strain Relief Connector</b>				
	1/2	E031050	25	3,476.66
	3/4	E031075	25	3,476.66
<b>Pipe Strap PVC - 2 Hole</b>				
	1/2	E039050	300	88.74
	3/4	E039075	200	105.10
	1	E039100	200	133.99
	1 1/4	E039125	200	145.01
	1 1/2	E039150	200	170.33
	2	E039200	200	214.16
<b>Duplex Floor Box</b>				
	3/4 (4)	E068004	9	6,729.65
	3/4 (2) x 1 (2)	E068001	9	6,729.65
Includes Reducer Bushings, Leveling Ring and Pour Cover				
<b>Duplex Floor Box Cover</b>				
	Poly Bronze Cover	E068003	10	8,409.11
<b>Junction Box with Gasket (Brass Screws and Inserts)</b>				
	4 x 4 x 2	E551442	15	3,726.54
	4 x 4 x 4	E551444	10	6,026.96
	4 x 4 x 6	E551446	8	6,117.93
	5 x 5 x 2	E551552	12	6,953.10
	6 x 6 x 4	E551664	15	11,172.71
	6 x 6 x 6	E551666	4	13,197.61
	8 x 8 x 4	E551884	4	17,428.78
	8 x 8 x 7	E551887	4	23,088.99
	12 x 12 x 4	E55112124	2	34,044.52
	12 x 12 x 6	E55112126	4	39,499.18
	12 x 12 x 8	E55112128	3	43,884.20

• List Price per 100 Units  
• Tested and Listed by CSA and UL

Item	Size In Inches	Part Number	Box Qty	List Price
<b>Access Fitting Type C (Self-Tapping Screws)</b>				
	1/2	E032050	25	997.94
	3/4	E032075	15	1,453.17
	1	E032100	10	1,579.15
	1 1/4	E032125	10	2,402.69
	1 1/2	E032150	10	2,577.09
	2	E032200	5	4,559.95
	2 1/2	E032250	5	19,032.08
	3	E032300	5	21,201.56
	3 1/2	E032350	4	21,748.72
4	E032400	4	22,833.50	

Item	Size In Inches	Part Number	Box Qty	List Price
<b>Access Fitting Type LB (Self-Tapping Screws)</b>				
	1/2	E033050	25	960.79
	3/4	E033075	15	1,233.06
	1	E033100	10	1,357.36
	1 1/4	E033125	10	2,063.35
	1 1/2	E033150	10	2,481.60
	2	E033200	5	4,391.04
	2 1/2	E033250	5	15,946.97
	3	E033300	5	16,475.71
	3 1/2	E033350	4	17,661.54
4	E033400	4	18,074.07	

Item	Size In Inches	Part Number	Box Qty	List Price
<b>Access Fitting Type LL (Self-Tapping Screws)</b>				
	1/2	E034050	25	983.97
	3/4	E034075	15	1,385.38
	1	E034100	10	1,498.41
	1 1/4	E034125	10	2,195.99
	1 1/2	E034150	10	2,577.09
	2	E034200	5	4,424.62
	2 1/2	E034250	5	19,032.08
	3	E034300	5	21,204.74
	3 1/2	E034350	4	21,748.72
4	E034400	4	22,833.50	

Item	Size In Inches	Part Number	Box Qty	List Price
<b>Access Fitting Type LR (Self-Tapping Screws)</b>				
	1/2	E035050	25	983.97
	3/4	E035075	15	1,385.39
	1	E035100	10	1,498.42
	1 1/4	E035125	10	2,195.99
	1 1/2	E035150	10	2,577.09
	2	E035200	5	4,424.61
	2 1/2	E035250	5	19,032.09
	3	E035300	5	21,204.74
	3 1/2	E035350	4	21,748.71
4	E035400	4	22,833.50	

Item	Size In Inches	Part Number	Box Qty	List Price
<b>Access Fitting Type E (Self-Tapping Screws)</b>				
	1/2	E036050	25	1,004.37
	3/4	E036075	15	1,459.68
	1	E036100	10	1,528.90
	1 1/4	E036125	10	2,157.26
	1 1/2	E036150	10	2,577.09
	2	E036200	5	4,559.95
	2 1/2	E036250	5	16,640.11
	3	E036300	5	17,136.30
	3 1/2	E036350	4	19,518.60
4	E036400	4	20,218.52	

Item	Size In Inches	Part Number	Box Qty	List Price
<b>Access Fitting Type T (Self-Tapping Screws)</b>				
	1/2	E037050	25	1,239.33
	3/4	E037075	15	1,517.63
	1	E037100	10	1,581.61
	1 1/4	E037125	10	2,577.09
	1 1/2	E037150	10	3,394.13
	2	E037200	5	4,820.95
	2 1/2	E037250	2	19,032.08
	3	E037300	2	21,204.74
	3 1/2	E037350	1	21,748.72
4	E037400	1	22,833.50	

Item	Size In Inches	Part Number	Box Qty	List Price
<b>Access Fitting Type C (Brass Screws and Inserts)</b>				
	1/2	E532050	30	1,232.83
	3/4	E532075	20	1,692.33
	1	E532100	15	1,797.63
	1 1/4	E532125	15	2,977.29
	1 1/2	E532150	10	3,612.39
	2	E532200	15	6,183.88
	2 1/2	E532250	4	20,329.59
	3	E532300	4	22,614.60
	3 1/2	E532350	4	23,310.23
4	E532400	4	24,005.89	

Item	Size In Inches	Part Number	Box Qty	List Price
<b>Access Fitting Type LB (Brass Screws and Inserts)</b>				
	1/2	E533050	25	1,232.83
	3/4	E533075	25	1,692.33
	1	E533100	15	1,797.63
	1 1/4	E533125	20	2,977.29
	1 1/2	E533150	10	3,612.39
	2	E533200	15	6,183.88
	2 1/2	E533250	5	20,329.59
	3	E533300	5	22,614.60
	3 1/2	E533350	5	23,310.23
4	E533400	5	24,005.89	

Item	Size In Inches	Part Number	Box Qty	List Price
<b>Access Fitting Type LL (Brass Screws and Inserts)</b>				
	1/2	E534050	25	1,232.83
	3/4	E534075	20	1,692.33
	1	E534100	15	1,797.63
	1 1/4	E534125	10	2,977.29
	1 1/2	E534150	10	3,612.39
	2	E534200	10	6,183.88
	2 1/2	E534250	4	20,329.59
	3	E534300	4	22,614.60
	3 1/2	E534350	5	23,310.23
4	E534400	5	24,005.89	

Item	Size In Inches	Part Number	Box Qty	List Price
<b>Access Fitting Type LR (Brass Screws and Inserts)</b>				
	1/2	E535050	25	1,232.83
	3/4	E535075	20	1,692.33
	1	E535100	15	1,797.63
	1 1/4	E535125	10	2,977.29
	1 1/2	E535150	10	3,612.39
	2	E535200	10	6,183.88
	2 1/2	E535250	4	20,329.59
	3	E535300	4	22,614.60
	3 1/2	E535350	5	23,310.23
4	E535400	5	24,005.89	

Item	Size In Inches	Part Number	Box Qty	List Price
<b>Access Fitting Type E (Brass Screws and Inserts)</b>				
	1/2	E536050	30	1,312.97
	3/4	E536075	20	1,802.35
	1	E536100	15	1,914.48
	1 1/4	E536125	20	3,170.81
	1 1/2	E536150	10	3,847.20
	2	E536200	15	6,798.85
	2 1/2	E536250	4	21,651.01
	3	E536300	4	24,084.54
	3 1/2	E536350	4	24,825.40
4	E536400	4	25,566.29	

Item	Size In Inches	Part Number	Box Qty	List Price
<b>Access Fitting Type T (Brass Screws and Inserts)</b>				
	1/2	E537050	30	1,447.99
	3/4	E537075	20	1,954.49
	1	E537100	25	2,077.21
	1 1/4	E537125	15	3,440.33
	1 1/2	E537150	10	4,174.22
	2	E537200	10	7,376.77
	2 1/2	E537250	4	23,491.35
	3	E537300	4	26,131.72
	3 1/2	E537350	4	26,935.56
4	E537400	4	27,739.43	

• List Price per 100 Units  
• Tested and Listed by CSA and UL

Item	Size In Inches	Part Number	Box Qty	List Price
<b>Access Fitting Type TB (Self-Tapping Screws)</b>				
	1/2	E069050	30	2,019.75
	3/4	E069075	20	2,256.01
	1	E069100	10	2,342.45
	1 1/4	E069125	10	3,069.47
	1 1/2	E069150	15	4,342.02
	2	E069200	10	5,650.10
	2 1/2	E069250	10	13,459.67
	3	E069300	4	13,937.05
	3 1/2	E069350	4	18,621.24
4	E069400	4	18,983.22	

<b>Single Gang Cover Plate F Series (Self-Tapping Screws)</b>				
	A. Toggle	E046002	100	1,123.04
	B. Duplex	E046001	100	1,123.04
	C. 15 Amp	E046004	100	1,123.04
	D. 20 Amp	E046003	100	1,123.04
	E. 30 Amp	E046005	100	1,123.04
	F. Blank w/ Gasket	E046006	50	2,170.90

<b>Single Gang Weatherproof Cover Plate (Self-Tapping Screws)</b>				
	A. Toggle w/ Cover	E047002	10	2,822.57
	B. Plunger w/ Cover	E047008	10	3,673.83
	C. Toggle	E047009	10	3,216.84
	D. Duplex	E047001	10	3,073.47
	D. Duplex White	E047010	20	3,073.47
	E. Ground Fault	E047007	10	3,288.52
	E. Ground Fault White	E047011	20	3,288.52
	F. 15 Amp	E047003	10	3,794.80
	F. 20 Amp	E047004	10	5,417.80
F. 30 Amp	E047005	10	5,417.80	
F. 50 Amp	E047006	10	6,370.49	

<b>Double Gang Weatherproof Cover Plate (Self-Tapping Screws)</b>				
	B. GFI & Toggle	E049005	10	4,502.68
	C. Duplex & Toggle	E049006	10	4,590.97
	D. Double Duplex	E049007	10	4,371.85
	E. Double Toggle	E049008	10	5,244.22
	F. Blank w/ Gasket	E049009	25	2,486.13

<b>Single Gang Box F Series (For Self-Tapping Screws)</b>				
	A. 1/2 FS	E042001	10	2,585.98
	A. 3/4 FS	E042002	10	2,717.51
	B. 1/2 FSS	E042003	10	2,769.74
	B. 3/4 FSS	E042004	10	2,971.68
	C. 1/2 FSC	E042005	10	2,717.51
	C. 3/4 FSC	E042006	10	2,971.68
	D. 1/2 FSCC	E042007	10	2,972.87
D. 3/4 FSCC	E042008	10	3,365.87	

Item	Size In Inches	Part Number	Box Qty	List Price
<b>Access Fitting Type TB (Brass Screws and Inserts)</b>				
	1/2	E569050	30	2,272.22
	3/4	E569075	20	2,538.01
	1	E569100	10	2,635.26
	1 1/4	E569125	10	6,338.22
	1 1/2	E569150	15	6,739.00
	2	E569200	10	8,546.26
	2 1/2	E569250	10	15,142.14
	3	E569300	4	15,679.18
	3 1/2	E569350	4	20,948.01
4	E569400	4	21,356.13	

<b>Single Gang Cover Plate F Series (Brass Screws)</b>				
	A. Toggle	E546002	100	1,207.28
	B. Duplex	E546001	100	1,207.28
	C. 15 Amp	E546004	100	1,207.28
	D. 20 Amp	E546003	100	1,207.28
	E. 30 Amp	E546005	100	1,207.28
	F. Blank w/ Gasket	E546006	100	2,333.73

<b>Single Gang Weatherproof Cover Plate (Brass Screws)</b>				
	A. Toggle w/ Cover	E547002	20	3,034.27
	B. Plunger w/ Cover	E547008	20	3,949.37
	C. Toggle	E547009	20	3,458.10
	D. Duplex	E547001	20	3,303.98
	D. Duplex White	E547010	20	3,303.98
	E. Ground Fault	E547007	20	3,535.17
	E. Ground Fault White	E547011	20	3,535.17
	F. 15 Amp	E547003	20	4,079.40
	F. 20 Amp	E547004	20	5,824.14
F. 30 Amp	E547005	20	5,824.14	
F. 50 Amp	E547006	20	6,848.28	

<b>Double Gang Weatherproof Cover Plate (Brass Screws)</b>				
	B. GFI & Toggle	E549005	10	4,840.38
	C. Duplex & Toggle	E549006	10	4,935.29
	D. Double Duplex	E549007	10	4,699.74
	E. Double Toggle	E549008	10	5,637.53
	F. Blank w/ Gasket	E549009	25	2,672.59

<b>Single Gang Box with Gasket F Series (With Brass Inserts)</b>				
	A. 1/2 FS	E542001	10	2,909.22
	A. 3/4 FS	E542002	10	3,057.20
	B. 1/2 FSS	E542003	10	3,115.95
	B. 3/4 FSS	E542004	10	3,343.14
	C. 1/2 FSC	E542005	10	3,057.20
	C. 3/4 FSC	E542006	10	3,343.15
	D. 1/2 FSCC	E542007	10	3,344.48
D. 3/4 FSCC	E542008	10	3,786.61	

• List Price per 100 Units  
 • Tested and Listed by CSA and UL

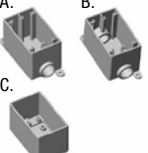

Item	Size In Inches	Part Number	Box Qty	List Price
<b>Single Gang Deep Box FD Series (For Self-Tapping Screws)</b>				
	A. 1/2 FDS	E043001	10	2,715.08
	A. 3/4 FDS	E043002	10	2,715.08
	A. 1 FDS	E043003	10	2,715.08
	B. 1/2 FDC	E043004	10	2,756.33
	B. 3/4 FDC	E043005	10	2,756.33
	B. 1 FDC	E043006	10	2,756.33
	C. Blank	E043007	10	2,745.60

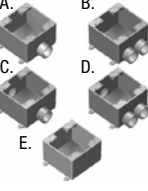
Item	Size In Inches	Part Number	Box Qty	List Price
<b>Double Gang Box F Series (For Self-Tapping Screws)</b>				
	A. 1/2 FS	E041001	5	3,691.15
	A. 3/4 FS	E041002	5	3,691.15
	A. 1 FS	E041003	5	3,691.15
	B. 1/2 FSS	E041004	5	4,431.07
	B. 3/4 FSS	E041005	5	4,431.07
	B. 1 FSS	E041006	5	4,431.07
	C. 1/2 FSC	E041007	5	3,760.73
	C. 3/4 FSC	E041008	5	3,760.73
	C. 1 FSC	E041009	5	3,760.73
	D. 1/2 FSCC	E041011	5	4,431.07
	D. 3/4 FSCC	E041012	5	4,431.07
	D. 1 FSCC	E041013	5	4,431.07
	E. Blank	E041010	5	3,889.72

Electrical Conduit PVC Cement (Low VOC)				Each
	1/2 Pint	34365	24	43.89
	Pint	34366	12	55.15
	Quart	34367	12	92.06

Duct Spacer	Intermediate Vertical Lock Spacer			
	2 x 1 1/2	IS2015	350	390.92
	2 x 2	IS2020	300	403.38
	2 x 3	IS2030	200	440.99
	3 x 1 1/2	IS3015	225	416.79
	3 x 2	IS3020	200	473.56
	3 x 3	IS3030	125	509.80
	4 x 1	IS4010	200	391.23
	4 x 1 1/2	IS4015	150	451.43
	4 x 2	IS4020	125	490.10
	4 x 3	IS4030	90	568.21
	5 x 1 1/2	IS5015	100	522.03
	5 x 2	IS5020	100	572.36
	5 x 3	IS5030	80	645.97
	6 x 1 1/2	IS6015	100	575.71
	6 x 2	IS6020	90	715.43
6 x 3	IS6030	70	979.44	
8 x 1 1/2	IS8015	60	1,650.09	
8 x 2	IS8020	60	1,746.11	

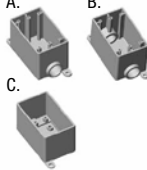
Item	Size In Inches	Part Number	Box Qty	List Price
<b>Single Gang Deep Box with Gasket FD Series (With Brass Inserts)</b>				
	A. 1/2 FDS	E543001	10	3,122.35
	A. 3/4 FDS	E543002	10	3,122.35
	A. 1 FDS	E543003	10	3,122.35
	B. 1/2 FDC	E543004	10	3,169.78
	B. 3/4 FDC	E543005	10	3,169.78
	B. 1 FDC	E543006	10	3,169.78
	C. Blank	E543007	10	3,644.77
C. 347 Volt	E543008	10	3,644.77	

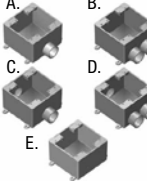
Item	Size In Inches	Part Number	Box Qty	List Price
<b>Double Gang Box with Gasket F Series (With Brass Inserts)</b>				
	A. 1/2 FS	E541001	10	4,244.82
	A. 3/4 FS	E541002	10	4,244.82
	A. 1 FS	E541003	10	4,244.82
	B. 1/2 FSS	E541004	10	5,095.72
	B. 3/4 FSS	E541005	10	5,095.72
	B. 1 FSS	E541006	10	5,095.72
	C. 1/2 FSC	E541007	10	4,324.83
	C. 3/4 FSC	E541008	10	4,324.83
	C. 1 FSC	E541009	10	4,324.83
	D. 1/2 FSCC	E541011	10	5,095.72
	D. 3/4 FSCC	E541012	10	5,095.72
	D. 1 FSCC	E541013	10	5,095.72
	E. Blank	E541010	10	4,473.17

Cold Pro PVC Cement (Low VOC)				Each
	Pint	33942	12	78.79
	Quart	33943	12	116.32

Recommended application temperature -15° to 110F°

Duct Spacer	Base Vertical Lock Spacer			
	2 x 1 1/2	BS2015	250	407.21
	2 x 2	BS2020	225	420.15
	2 x 3	BS2030	225	459.36
	3 x 1 1/2	BS3015	175	434.12
	3 x 2	BS3020	155	493.26
	3 x 3	BS3030	150	531.04
	4 x 1	BS4010	175	407.53
	4 x 1 1/2	BS4015	140	470.16
	4 x 2	BS4020	140	510.48
	4 x 3	BS4030	120	591.84
	5 x 1 1/2	BS5015	120	543.82
	5 x 2	BS5020	120	596.29
	5 x 3	BS5030	100	672.89
	6 x 1 1/2	BS6015	100	599.70
	6 x 2	BS6020	100	745.20
6 x 3	BS6030	95	1,001.76	
8 x 1 1/2	BS8015	50	1,735.60	
8 x 2	BS8020	50	1,836.61	

## E-SERIES ENT FITTINGS

Injection Molded in Sizes 1/2" - 6"

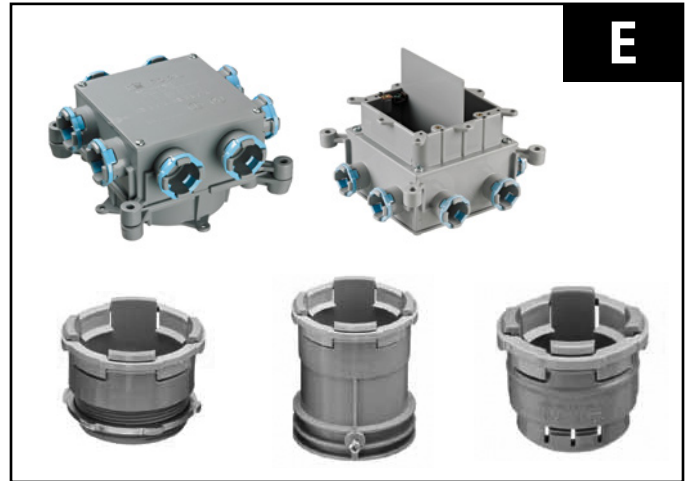



NAPCO offers a complete line of ENT fittings. NAPCO's non-metallic flexible tubing and fittings are certified by the CSA and UL.





NAPCO ENT systems are used in walls, floors, non-plenum ceilings and other general purpose applications.

- Residential dwellings
- Commercial buildings
- Industrial buildings
- Fire alarm systems
- Recreational vehicles
- Marinas and boat yards
- Institutions
- Solar voltaic systems

Item	Size In Inches	Part Number	Box Qty	List Price
<b>ENT Shallow Slab Box</b>				
	1/2 (8)	RSMBS-H-10	25	5,667.72
	1/2 (4) 3/4 (4)	RSMBS-H-10-15	25	5,863.15
	1/2 (4) 3/4 (2)	RSMBS-H-10-15-20	25	6,254.05
	1 (2)			
	1/2 (4) 1 (4)	RSMBS-H-10-20	25	6,153.13
	3/4 (8)	RSMBS-H-15	25	6,058.62
3/4 (4) 1 (4)	RSMBS-H-15-20	25	6,254.05	

Item	Size In Inches	Part Number	Box Qty	List Price
<b>ENT Shallow Single Gang Concrete Wall Box</b>				
	1/2	RSVSB-H-10	70	3,107.93
	3/4	RSVSB-H-15	70	3,156.07
	1	RSVSB-H-20	70	3,443.03

Item	Size In Inches	Part Number	Box Qty	List Price
<b>ENT Square Slab Box</b>				
	1/2 (8)	RSSB-H-10	25	6,888.38
	1/2 (4) 3/4 (4)	RSSB-H-10-15	25	7,125.93
	1/2 (4) 3/4 (2) 1 (2)	RSSB-H-10-15-20	25	7,600.92
	1/2 (4) 1 (4)	RSSB-H-10-20	25	7,559.39
	3/4 (8)	RSSB-H-15	25	7,517.86
	3/4 (4) 1 (4)	RSSB-H-15-20	25	7,600.96
	Divider Plate Sold separately	RSSB-H-DC	10	783.50

Item	Size In Inches	Part Number	Box Qty	List Price
<b>ENT Slab Box with Hub Extensions and Grey Lid</b>				
	1/2 (8)	RSMB-H-10	25	5,667.72
	1/2 (4) 3/4 (4)	RSMB-H-10-15	25	5,863.15
	1/2 (4) 3/4 (2)	RSMB-H-10-15-20	25	6,154.31
	1 (2)			
	1/2 (4) 1 (4)	RSMB-H-10-20	25	6,254.05
	3/4 (8)	RSMB-H-15	25	6,058.62
	3/4 (4) 1 (4)	RSMB-H-15-20	25	6,254.05

Lids may be color coded for service identification:  
Add Suffix: G (green), W (white), B (blue), Y (yellow), R (red)

Item	Size In Inches	Part Number	Box Qty	List Price
<b>ENT Coupling</b>				
	1/2	RKC10	150	277.80
	3/4	RKC15	100	320.57
	1	RKC20	50	651.58
	1 1/4	RKC25	50	1,798.52
	1 1/2	RKC30	40	1,998.32
	2	RKC35	25	2,220.40

Item	Size In Inches	Part Number	Box Qty	List Price
<b>EMT Adapter with Set Screw</b>				
	1/2	RKTC10	125	849.52
	3/4	RKTC15	100	1,025.12
	1	RKTC20	50	1,303.51
	1 1/4	RKTC25	50	1,745.90
	1 1/2	RKTC30	40	1,998.14
	2	RKTC35	15	2,568.46

Item	Size In Inches	Part Number	Box Qty	List Price
<b>ENT Clip Ring</b>				
	1/2	RKR10	200†	105.65
	3/4	RKR15	200†	114.47
	1	RKR20	200†	136.00
	1 1/4	RKR25	100*	221.72
	1 1/2	RKR30	100*	230.13
	2	RKR35	50^	339.37

† = 20/bag \* = 10/bag ^ = 5/bag

Item	Size In Inches	Part Number	Box Qty	List Price
<b>ENT Isolator Module Slab Box</b>				
	1/2 (8)	RSMB-10-IMB	20	6,517.87
	1/2 (4) 3/4 (4)	RSMB-10-15-IMB	20	6,742.62
	1/2 (4) 3/4 (2)	RSMB-10-15-20-IMB	20	7,192.15
	1 (2)			
	1/2 (4) 1 (4)	RSMB-10-20-IMB	20	7,076.10
	3/4 (8)	RSMB-15-IMB	20	6,967.41
3/4 (4) 1 (4)	RSMB-15-20-IMB	20	7,192.15	

Item	Size In Inches	Part Number	Box Qty	List Price
<b>ENT Deep Single Gang Concrete Wall Box</b>				
	1/2 (8)	RSVDB-H-10	25	7,904.35
	1/2 (4) 3/4 (4)	RSVDB-H-10-15	25	7,904.35
	1/2 (4) 3/4 (2)	RSVDB-H-10-15-20	25	7,904.35
	1 (2)			
	1/2 (4) 1 (4)	RSVDB-H-10-20	25	7,904.35
	3/4 (8)	RSVDB-H-15	25	7,904.35
3/4 (4) 1 (4)	RSVDB-H-15-20	25	7,904.35	

Item	Size In Inches	Part Number	Box Qty	List Price
<b>ENT Slab Box with Knockouts and Grey Lid</b>				
	1/2 (8)	RSMB-10	25	4,090.32
	1/2 (4) 3/4 (4)	RSMB-10-15	25	5,540.68
	1/2 (4) 3/4 (2)	RSMB-10-15-20	25	4,090.32
	1 (2)			
	1/2 (2) 3/4 (4)	RSMB-15-20-10	25	5,817.74
	1 (2)			
	3/4 (8)	RSMB-15	25	5,725.39
	3/4 (4) 1 (4)	RSMB-15-20	25	5,910.07

Lids may be color coded for service identification:  
Add Suffix: G (green), W (white), B (blue), Y (yellow), R (red)

Item	Size In Inches	Part Number	Box Qty	List Price
<b>ENT Threaded Terminal Adapter with Lock Nut</b>				
	1/2	RKTA10	150	296.86
	3/4	RKTA15	100	472.78
	1	RKTA20	50	1,093.81
	1 1/4	RKTA25	50	3,188.90
	1 1/2	RKTA30	50	3,543.17
	2	RKTA35	25	3,936.91

Item	Size In Inches	Part Number	Box Qty	List Price
<b>ENT Quick-Snap Terminal Adapter</b>				
	1/2	RKTS10	150	242.05
	3/4	RKTS15	100	534.96
	1	RKTS20	50	847.37

Item	Size In Inches	Part Number	Box Qty	List Price
<b>Heavy Duty Lock Nut</b>				
	1/2	RLN10	200	111.23
	3/4	RLN15	200	150.48
	1	RLN20	200	294.66
	1 1/4	RLN25	200	714.27
	1 1/2	RLN30	200	906.98
	2	RLN35	200	967.56

- List Price per 100 Units
- Tested and Listed by CSA and UL

Item	Size In Inches	Part Number	Box Qty	List Price
<b>Straight Stubby (Polyethylene)</b>				
	1/2	RECM10	150	1,034.59
	3/4	RECM15	150	1,115.15
	1	RECM20	200	1,149.46
	1 1/4	RECM25	200	1,298.43

Item	Size In Inches	Part Number	Box Qty	List Price
<b>Tapered Plug (Polyethylene)</b>				
	1/2	RTP10	250	218.31
	3/4	RTP15	100	228.20
	1	RTP20	100	337.34

Item	Size In Inches	Part Number	Box Qty	List Price
<b>45 Degree Angled Form Stubby (Polyethylene)</b>				
	1/2	RKASTB10	50	1,293.31
	3/4	RKASTB15	50	1,394.12
	1	RKASTB20	50	1,437.40
	1 1/4	RKASTB25	50	1,623.02
	1 1/2	RKASTB30	50	1,723.43
	2	RKASTB35	50	1,976.39

Item	Size In Inches	Part Number	Box Qty	List Price
<b>ENT Slab Box Extension Ring</b>				
	1 Extension	RSMBXTENSION	20	2,717.59

Our various pipe and fittings solutions have been manufactured to meet the needs of our customers and their applications.

**Contact our Sales Office for more information.**

- **Municipal Pipe & Fittings**
- **Plumbing Pipe & Fittings**
- **Industrial Pipe & Fittings**
- **Electrical Pipe & Fittings**

**[napcopipe.com](http://napcopipe.com)**

Sales & Distribution Center  
NAPCO Pipe & Fittings  
56400 Mound Road  
Shelby Township, MI 48316  
T 1.800.232.5690  
F 1.586.781.0888

©2020 NAPCO, a Westlake company All rights reserved GE-PL-021-US-EN-0320.1

