

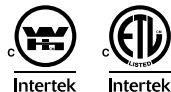

Installation Guide for **GVS-65 & GVS-90 GAS VENTING SOLUTIONS**

NAPCO has developed GVS-65 and GVS-90, complete PVC and CPVC pipe, fittings and accessories designed for use as Type BH, Class IIA and IIB gas venting systems with temperature ratings of up to and including 65°C (GVS-65) and 90°C (GVS-90). NAPCO GVS-65 and GVS-90 have been third party certified to ULC S636.



These systems include fittings, pipe, solvent cement and primer. Only GVS-65 and GVS-90 components may be used as part of these systems- do not use fittings, pipe, solvent cement or primer from any other manufacturer with the NAPCO GVS-65 and GVS-90 systems. Do not mix pipe, fittings or joining methods from different manufacturers.

GVS-65 (PVC) pipe and fittings are white in colour. GVS-65 (PVC) solvent cement is grey in colour and GVS-65/GVS-90 primer is clear or purple. GVS-90 (CPVC) pipe and fittings are grey in colour. GVS-90 (CPVC) solvent cement is orange in colour and GVS-65/GVS-90 primer is clear or purple.

- Prior to the start of installation, all components must be examined for possible damage due to shipping.
- Proper joint construction is essential for safe installation and operation. The joint construction procedure included in these instructions shall be followed exactly as written for assembly of NAPCO GVS-65 and GVS-90, on page 9 of this guide.
- Once installed, these venting systems must be free to expand and contract and must be supported in accordance with these instructions. Check for unrestricted vent movement through walls, ceilings and roof penetrations. GVS-65 and GVS-90 require zero clearance to combustible construction.
- Installation shall comply with the latest edition of CAN/CSA-B149.1 including supplements, the gas appliance manufacturer's installation instructions and local building codes, and shall be undertaken by qualified personnel.



Installation Guide for **GVS-65 & GVS-90 GAS VENTING SOLUTIONS**

All system installations shall be inspected by a qualified inspector prior to being placed into operation and at least once per year after start of operation, as per the authority having jurisdiction.

Vent piping which penetrates fire separations in buildings shall be properly firestopped in accordance with the applicable standards.

Prior to installation of these systems, the authority having jurisdiction (such as gas inspection authority, municipal building department, fire department, fire prevention bureau, etc.) should be consulted to determine the need to obtain a permit.

Acceptance of these systems is dependent upon full compliance with the installation guide.

The safe operation of a system is based on the use of parts supplied by the manufacturer and the performance of the system may be affected if the combination of these parts is not used in actual building construction. For maximum allowable intake or exhaust vent length and maximum allowable number of fittings in a installation refer to appliance manufacturer's instructions.

All framing of openings in walls, roofs, ceilings and floors shall be as per the applicable code.

General Venting:

All installations of vent piping shall be according to CAN/CSA-B149.1 and the gas appliance manufacturer's installation instructions, and shall comply with all other applicable codes. Vent piping which runs through unconditioned spaces must be insulated.

Horizontal Venting:

Horizontal piping must slope back towards the appliance with a minimum slope of 20mm per 1000mm to allow condensate to drain toward the appliance. Consult the appliance manufacturer's installation instructions for further details regarding the installation of condensate drain fittings. Horizontal piping must be supported by straps with a maximum spacing of 1.2 metres and at all changes in direction. Supports must be installed such that movement due to expansion and contraction can occur.

Straps:

Straps should have a smooth surface (no sharp edges) and be compatible with pipe and fitting materials.



Installation Guide for GVS-65 & GVS-90 GAS VENTING SOLUTIONS

Vertical Venting:

In the case of vertical piping in a multiple storey structure, the pipe shall be supported at its base and at the floor level of alternate storeys above the base by anchors that can bear the weight of pipe and fittings above it.

Expansion and Contraction:

Pipe products expand and contract with changes in temperature. This variation in length depends on the coefficient of thermal expansion of the pipe material. Different pipe diameters or wall thicknesses do not change the rate of thermal expansion or contraction for each pipe material.

The Coefficient of Thermal Expansion for PVC is as follows:

3×10^{-5} in (expansion/contraction)/in (pipe length)/°F (change in temperature)

5.4×10^{-5} mm (expansion/contraction)/mm (pipe length)/°C (change in temperature)

The following tables give values for Expansion/Contraction for different changes in temperature and lengths of PVC pipe runs.

Expansion/Contraction of PVC (mm)										
Δ T (°C)	Length of Pipe Run (m)									
	2	4	6	8	10	12	14	16	18	20
5	0.54	1.08	1.62	2.16	2.70	3.24	3.78	4.32	4.86	5.40
10	1.08	2.16	3.24	4.32	5.40	6.48	7.56	8.64	9.72	10.80
15	1.62	3.24	4.86	6.48	8.10	9.72	11.34	12.96	14.58	16.20
20	2.16	4.32	6.48	8.64	10.80	12.96	15.12	17.28	19.44	21.60
25	2.70	5.40	8.10	10.80	13.50	16.20	18.90	21.60	24.30	27.00
30	3.24	6.48	9.72	12.96	16.20	19.44	22.68	25.92	29.16	32.40
35	3.78	7.56	11.34	15.12	18.90	22.68	26.46	30.24	34.02	37.80
40	4.32	8.64	12.96	17.28	21.60	25.92	30.24	34.56	38.88	43.20
45	4.86	9.72	14.58	19.44	24.30	29.16	34.02	38.88	43.74	48.60
50	5.40	10.80	16.20	21.60	27.00	32.40	37.80	43.20	48.60	54.00

Expansion/Contraction of PVC (in)										
Δ T (°F)	Length of Pipe Run (ft)									
	5	10	15	20	25	30	35	40	45	50
5	0.01	0.02	0.03	0.04	0.05	0.05	0.06	0.07	0.08	0.09
10	0.02	0.04	0.05	0.07	0.09	0.11	0.13	0.14	0.16	0.18
15	0.03	0.05	0.08	0.11	0.14	0.16	0.19	0.22	0.24	0.27
20	0.04	0.07	0.11	0.14	0.18	0.22	0.25	0.29	0.32	0.36
25	0.05	0.09	0.14	0.18	0.23	0.27	0.32	0.36	0.41	0.45
30	0.05	0.11	0.16	0.22	0.27	0.32	0.38	0.43	0.49	0.54
35	0.06	0.13	0.19	0.25	0.32	0.38	0.44	0.50	0.57	0.63
40	0.07	0.14	0.22	0.29	0.36	0.43	0.50	0.58	0.65	0.72
45	0.08	0.16	0.24	0.32	0.41	0.49	0.57	0.65	0.73	0.81
50	0.09	0.18	0.27	0.36	0.45	0.54	0.63	0.72	0.81	0.90



Installation Guide for GVS-65 & GVS-90 GAS VENTING SOLUTIONS

The Coefficient of Thermal Expansion for CPVC is as follows:

3.8×10^{-5} in (expansion/contraction) /in (pipe length) / °F (change in temperature)

6.8×10^{-5} mm (expansion/contraction) /mm (pipe length) / °C (change in temperature)

The following tables give values for Expansion/Contraction for different changes in temperature and lengths of CPVC pipe runs.

Expansion/Contraction of CPVC (mm)										
Δ T (°C)	Length of Pipe Run (m)									
	2	4	6	8	10	12	14	16	18	20
5	0.68	1.36	2.04	2.72	3.40	4.08	4.76	5.44	6.12	6.80
10	1.36	2.72	4.08	5.44	6.80	8.16	9.52	10.88	12.24	13.60
15	2.04	4.08	6.12	8.16	10.20	12.24	14.28	16.32	18.36	20.40
20	2.72	5.44	8.16	10.88	13.60	16.32	19.04	21.76	24.48	27.20
25	3.40	6.80	10.20	13.60	17.00	20.40	23.80	27.20	30.60	34.00
30	4.08	8.16	12.24	16.32	20.40	24.48	28.56	33.32	36.72	40.80
35	4.76	9.52	14.28	19.04	23.80	28.56	33.32	38.08	42.84	47.60
40	5.44	10.88	16.32	21.76	27.20	32.64	38.08	43.52	48.96	54.40
45	6.12	12.24	18.36	24.48	30.60	36.72	42.84	48.96	55.08	61.20
50	6.80	13.60	20.40	27.20	34.00	40.80	47.60	54.40	61.20	68.00

Expansion/Contraction of CPVC (in)										
Δ T (°F)	Length of Pipe Run (ft)									
	5	10	15	20	25	30	35	40	45	50
5	0.01	0.02	0.03	0.05	0.06	0.07	0.08	0.09	0.10	0.11
10	0.02	0.05	0.07	0.09	0.11	0.14	0.16	0.18	0.21	0.23
15	0.03	0.07	0.10	0.14	0.17	0.21	0.24	0.27	0.31	0.34
20	0.05	0.09	0.14	0.18	0.23	0.27	0.32	0.36	0.41	0.46
25	0.06	0.11	0.17	0.23	0.29	0.34	0.40	0.46	0.51	0.57
30	0.07	0.14	0.21	0.27	0.34	0.41	0.48	0.55	0.62	0.68
35	0.08	0.16	0.24	0.32	0.40	0.48	0.56	0.64	0.72	0.80
40	0.09	0.18	0.27	0.36	0.46	0.55	0.64	0.73	0.82	0.91
45	0.10	0.21	0.31	0.41	0.51	0.62	0.72	0.82	0.92	1.03
50	0.11	0.23	0.34	0.46	0.57	0.68	0.80	0.91	1.03	1.14

The following are suggestions for accommodating expansion/contraction with PVC/CPVC pipe:

- Pipe supports should be installed loosely enough to allow linear movement of the pipe without damaging the pipe.
- Properly designed offsets should be used to accommodate expansion and contraction for long pipe runs.
- Pipe should not be anchored rigidly in walls or against joists-pipe must be allowed to move freely at every support location.



Vent Termination

General Termination:

The venting system shall terminate in accordance with the requirements of CAN/CSA B149.1, the gas appliance manufacturer's installation instructions and the local building code.

A venting system shall not terminate (CAN/CSA B149.1):

- (a) where it may cause hazardous frost or ice accumulations on adjacent property surfaces;
- (b) less than 7 ft (2.1 m) above a paved sidewalk or a paved driveway that is located on public property;
- (c) within 6 ft (1.8 m) of a mechanical air-supply inlet to any building;
- (d) above a regulator within 3 ft (900 mm) horizontally of the vertical centreline of the regulator vent outlet to a maximum vertical distance of 15 ft (4.5 m);
- (e) any distance less than that of any gas pressure regulator vent outlet;
- (f) less than 1 ft (300 mm) above grade level;
- (g) within the following distances of a window or door that can be opened in any building, of any nonmechanical air-supply inlet to any building, or of the combustion air inlet of any other appliance:
 - (i) 6 in (150 mm) for inputs up to and including 10 000 Btuh (3 kW);
 - (ii) 12 in (300 mm) for inputs from 10 000 Btuh (3 kW) up to and including 100 000 Btuh (30 kW); and
 - (iii) 3 ft (900 mm) for inputs exceeding 100 000 Btuh (30 kW); and
- (h) underneath a veranda, porch, or deck unless
 - (i) the veranda, porch, or deck is fully open on a minimum of two sides beneath the floor; and
 - (ii) the distance between the top of the vent termination and the underside of the veranda, porch, or deck is greater than 1 ft (300 mm).



Installation Guide for GVS-65 & GVS-90 GAS VENTING SOLUTIONS

Vent Termination - Continued:

Horizontal Termination:

Horizontal vents pass through the exterior wall of the building. Horizontal vent termination shall be as per the appliance manufacturer's instructions and the local building code. Figure 1 is a typical horizontal termination.

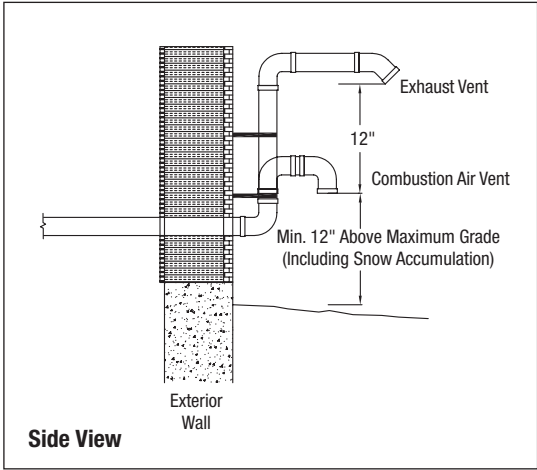
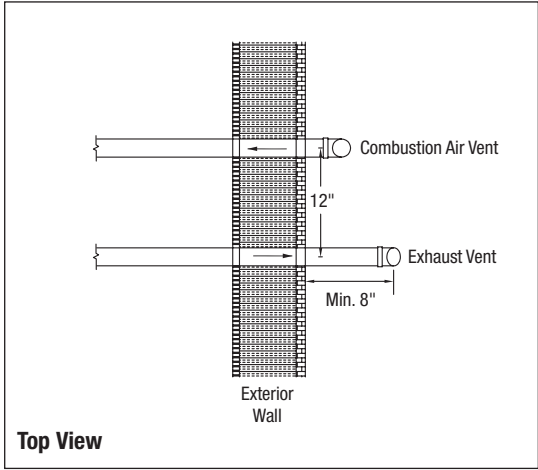

Figure 1. Example of a horizontal termination.



Installation Guide for GVS-65 & GVS-90 GAS VENTING SOLUTIONS

Vent Termination - Continued:

Vertical Termination:

Vent piping can also be installed in a vertical position with the vent terminating through the roof. In this instance, all framing, firestopping and flashing shall be installed as per the manufacturer's appliance instructions and the local building code. See Figure 2.

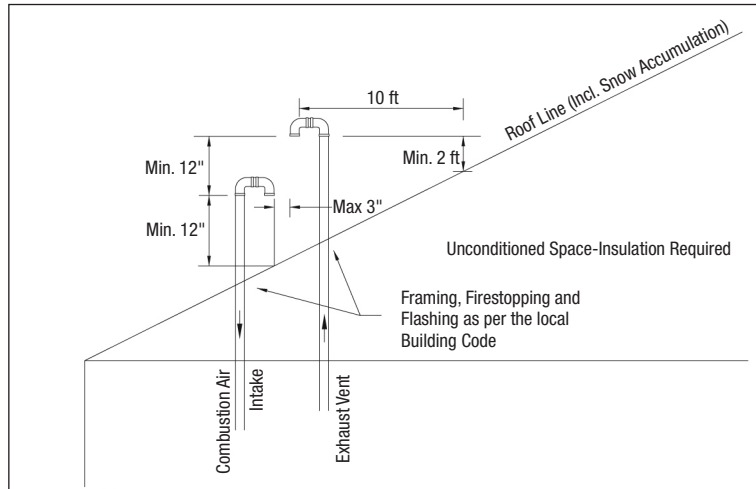

Figure 2. Example of a vertical termination.



Installation Guide for GVS-65 & GVS-90 GAS VENTING SOLUTIONS

Vent Termination - Continued:

Side Wall Vent Termination Kit and Concentric Vent Termination Kit:

These 2" and 3" vent kits are used to terminate the intake and exhaust of a gas appliance. It is the responsibility of the installer to ensure the correct version is used based on the appliance manufacturer's instructions (PVC/CPVC). See Figure 4 and Figure 5 below. For safe installation, refer to the installation instructions for both kits.

Joint Construction:

- Use only NAPCO GVS-65/GVS-90 primer and solvent cements.
- Use solvent cement and primer prior to expiration date.
- Above 0°C ambient temperature, joints may be assembled without the use of primer, provided adequate penetration and softening of the pipe/fitting surface can be achieved with solvent cement alone.
- Primer is **mandatory** for installation temperatures at or below 0°C and for installations of 6" and 8" of GVS-90 in all conditions.
- Use CPVC Solvent Cement between PVC and CPVC materials.

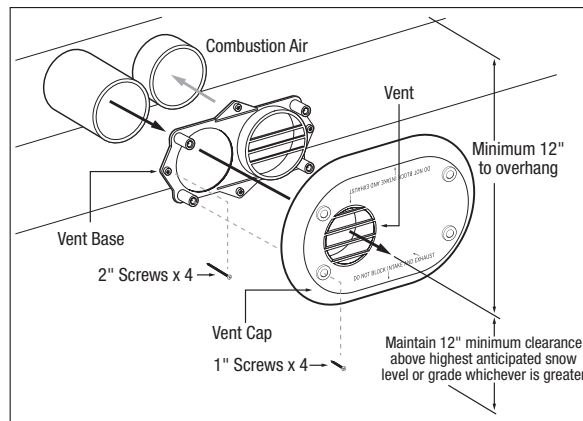

Figure 4. Side Wall Vent Termination Kit

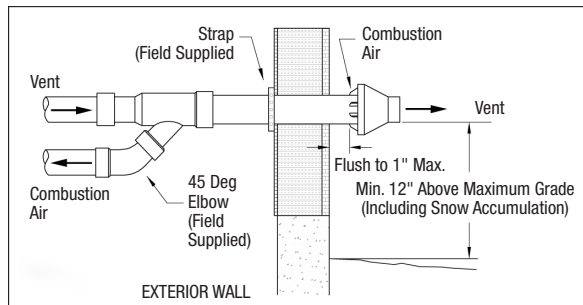

Figure 5. Concentric Vent Termination Kit



Installation Guide for **GVS-65 & GVS-90 GAS VENTING SOLUTIONS**

Solvent Cementing Procedure With Primer

1. Assemble materials for the job, including correct solvent cement, primer and correctly sized applicator.
2. Cut pipe as square as possible. Do not use a diagonal cut, as it reduces the bonding area in the joint.
3. If plastic tubing cutters are used, care must be taken to remove any raised bead at the end of the pipe, caused by cutting. A file or reamer may be used to remove the bead.
4. Remove burrs from the inside and outside of the pipe end, as these will hinder the integrity of the joint. All sharp edges should be removed from the inside and outside edges of the pipe to prevent the pipe from pushing the solvent cement into the fitting socket, thereby causing a weak spot to form. The pipe end should be chamfered, as shown in Figure 6.

Figure 6.

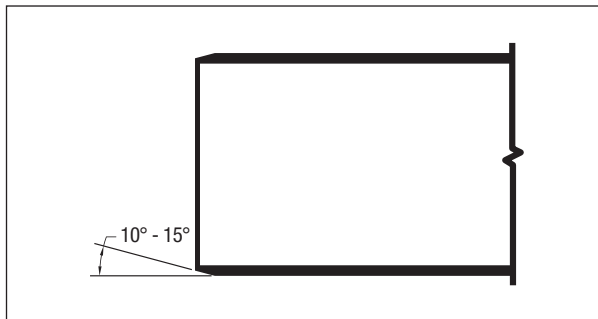



Installation Guide for **GVS-65 & GVS-90 GAS VENTING SOLUTIONS**

Solvent Cementing Procedure With Primer - Continued:

5. All dirt, grease and moisture should be removed from the pipe and socket by thoroughly wiping with a clean, dry cloth.
6. Dry fit pipe and fitting joints prior to cementing. For proper interference fit, the pipe should go easily into the socket approximately 1/3 to 2/3 of the socket depth. If there is no interference fit, **DO NOT** use those fittings.
7. The applicator should be sized according to the size of pipe and fittings being joined. The brush width of the applicator should be equal to approximately 1/2 of the pipe diameter.
8. Primer is used to penetrate and soften the surfaces so that they will fuse together under a wide variety of conditions. The penetration or softening can be checked by dragging the edge of a knife or sharp object over the coated surface. If a few thousandths of an inch of the primed surface can be scratched or scraped away, proper penetration has occurred. Varying weather conditions affect priming and cementing action and may require more time or repeated applications to either or both surfaces.
9. Using the correct applicator size (see #7), aggressively work the primer into the socket, keeping the surface and applicator wet until the surface has softened, re-dipping the applicator as required. When the surface is primed, remove any puddles of primer from the socket.
10. Aggressively work the primer on to the end of the pipe, to a point 1/2" beyond the depth of the socket.
11. Perform a second application of primer in the socket.



Installation Guide for **GVS-65 & GVS-90 GAS VENTING SOLUTIONS**

Solvent Cementing Procedure With Primer - Continued:

12. While the surfaces are still wet, the appropriate solvent cement should be applied.
13. Using the correct applicator size, aggressively work a full, even layer of cement onto the pipe end to a point equal to the depth of the socket. Do not brush out to a thin paint type layer, as this will dry within a few seconds.
14. Aggressively work a medium layer of cement into the fitting socket; avoid puddling cement in the socket. On the pipe end, do not coat beyond the socket depth or allow cement to run down into the pipe beyond the socket.
15. Apply a second full, even layer of cement on the pipe.
16. Immediately, while the cement is still wet, assemble the joint. Use enough force to ensure that the pipe is fully inserted into the socket. Twist the pipe a $\frac{1}{4}$ turn as it is being inserted.
17. Hold the joint together for approximately 30 seconds to avoid push out.
18. After assembly, inspect the joint to ensure that there is a ring or bead of cement completely around the juncture of the pipe and socket. If there are voids in this ring, sufficient cement was not applied and the joint may be defective.
19. Wipe off excess cement without disturbing the joint.
20. Handle newly cemented joints with care until initial set has taken place. Follow set and cure times before handling or testing the system.



Installation Guide for **GVS-65 & GVS-90 GAS VENTING SOLUTIONS**

Solvent Cementing Procedure Without Primer

Repeat steps 1 to 7 from the previous section.

8. The penetration or softening can be checked by applying a normal layer of solvent cement to a scrap piece of pipe and dragging the edge of a knife or sharp object over the coated surface. If a few thousandths of an inch of the coated surface can be scratched or scraped away, proper penetration has occurred. Varying weather conditions affect cementing action and may require more time, repeated applications to either or both surfaces or the use of primer.
9. Using the correct applicator size, aggressively work a full, even layer of cement onto the pipe end to a point equal to the depth of the socket. Do not brush out to a thin paint type layer, as this will dry within a few seconds. Do not coat beyond the socket depth or allow cement to run down into the pipe beyond the socket.
10. Aggressively work a medium layer of cement into the fitting socket; avoid puddling cement in the socket.
11. Apply a second full, even layer of cement on the pipe to a point equal to the depth of the socket.
12. Immediately, while the cement is still wet, assemble the joint. Use enough force to ensure that the pipe is fully inserted into the socket. Twist the pipe a $\frac{1}{4}$ turn as it is being inserted.
13. Hold the joint together for approximately 30 seconds to avoid push out.



Installation Guide for GVS-65 & GVS-90 GAS VENTING SOLUTIONS

Solvent Cementing Procedure Without Primer - Continued:

14. After assembly, inspect the joint to ensure that there is a ring or bead of cement completely around the juncture of the pipe and socket. If there are voids in this ring, sufficient cement was not applied and the joint may be defective.
15. Wipe off excess cement without disturbing the joint.
16. Handle newly cemented joints with care until initial set has taken place. Follow set and cure times before handling or testing the system.

Set Times

Average Initial Set Times		
Temperature Range	1½" to 2"	2½" to 8"
15° C to 40° C	5 Minutes	30 Minutes
5° C to 15° C	10 Minutes	2 Hours
-16° C to 5° C	15 Minutes	12 hours

Joint Cure Schedule

Average Joint Cure Schedule		
Relative Humidity 60% or Less	Cure Time Pipe Sizes 1½" to 2"	Cure Time Pipe Sizes 2½" to 8"
Temperature Range During Assembly and Cure Periods		
15° C to 40° C	5 Minutes	30 Minutes
5° C to 15° C	10 Minutes	2 Hours
-16° C to 5° C	15 Minutes	12 hours

In damp or humid weather allow 50% more cure time.

Estimated Solvent Cement Requirements

Average Number of Joints Per Litre of Solvent Cement							
Pipe/Fitting Diameter	1½"	2"	2½"	3"	4"	6"	8"
Number of Joints	90	60	40	40	30	10	5

Estimated Primer Requirements

Average Number of Joints Per Litre of Primer							
Pipe/Fitting Diameter	1½"	2"	2½"	3"	4"	6"	8"
Number of Joints	180	120	80	80	60	20	10



Installation Guide for **GVS-65 & GVS-90 GAS VENTING SOLUTIONS**

Solvent Cementing Practices

Solvent Cementing in Cold Weather:

- Store pipe and fittings in a heated area. Prefabricate as much of the system as possible in a heated area.
- When not in use, store sealed solvent cement and primer between 5°C and 21°C. Do not use open flame or electric heaters to warm cements and primers.
- Take care to remove moisture, ice and snow from the mating surfaces.

Solvent Cementing in Hot Weather:

- At the time of assembly, the surface temperature of the mating surfaces should not exceed 45°C. Shade or shelter the joint surfaces from direct sunlight for at least 1 hour prior to joining and during the joining process. If necessary, swab the mating surfaces with clean, wet rags to reduce the surface temperature (thoroughly dry surfaces before applying primer or cement).
- Apply cement quickly and join pipe to fitting as quickly as possible after applying the cement.
- Keep solvent cement container closed or covered when not in use, to minimize solvent loss.

Solvent Cementing in Wet Conditions:

- Mating surfaces must be dry when the joint is made.
- Work under a cover or canopy to keep rain off pipe and fittings.
- Work quickly after drying the pipe and fitting to avoid condensation.
- Allow a longer cure time before the system is tested or used.



Installation Guide for **GVS-65 & GVS-90 GAS VENTING SOLUTIONS**

Storage and Handling of Solvent Cement and Primer:

- Solvent cement and primer contain highly flammable solvents. Follow all specific safety precautions provided on container label and Material Safety Data Sheet (MSDS).
- Keep primer and solvent cement away from heat, sparks and open flame.
- Storage
 - Keep containers tightly closed except when in use.
 - Containers display manufactured date on bottom of the can.
 - Generally, solvent cement can be used up to 2 years from manufactured date.
 - Generally, primers can be used up to 3 years from manufactured date.
 - If solvent cement or primer are “Jelly-like” upon opening the can, do NOT use.
- Ensure proper ventilation of work area and avoid inhaling solvent vapours.
- Where the possibility of splashing exists, wear proper eye protection or a face shield.
- Avoid contact with skin.
- Do not attempt to thin or dilute solvent cements or primers.
- When not in use, store sealed solvent cement and primer between 5°C and 21°C. Do not use open flame or electric heaters to warm cements and primers.



Installation Guide for **GVS-65 & GVS-90 GAS VENTING SOLUTIONS**

Sales & Distribution Centres:

Langley, BC, Canada
T/F 1.800.663.0696
F 1.800.663.6564

Woodbridge, ON, Canada
T/F 1.866.769.7473
F 905.856.3986

Laval, QC, Canada
T/F 1.800.465.9754
F 450.688.6624

Distribution Centres:

Calgary, AB, Canada
T/F 1.800.663.0696
F 1.800.663.6564

Winnipeg, MB, Canada
T/F 1.800.663.0696
F 1.800.663.6564

napcopipe.com | 1.855.624.7473