

SIGNED DRAWINGS MUST ACCOMPANY PURCHASE ORDER OR DIMENSIONS OF FITTINGS WILL NOT BE GUARANTEED

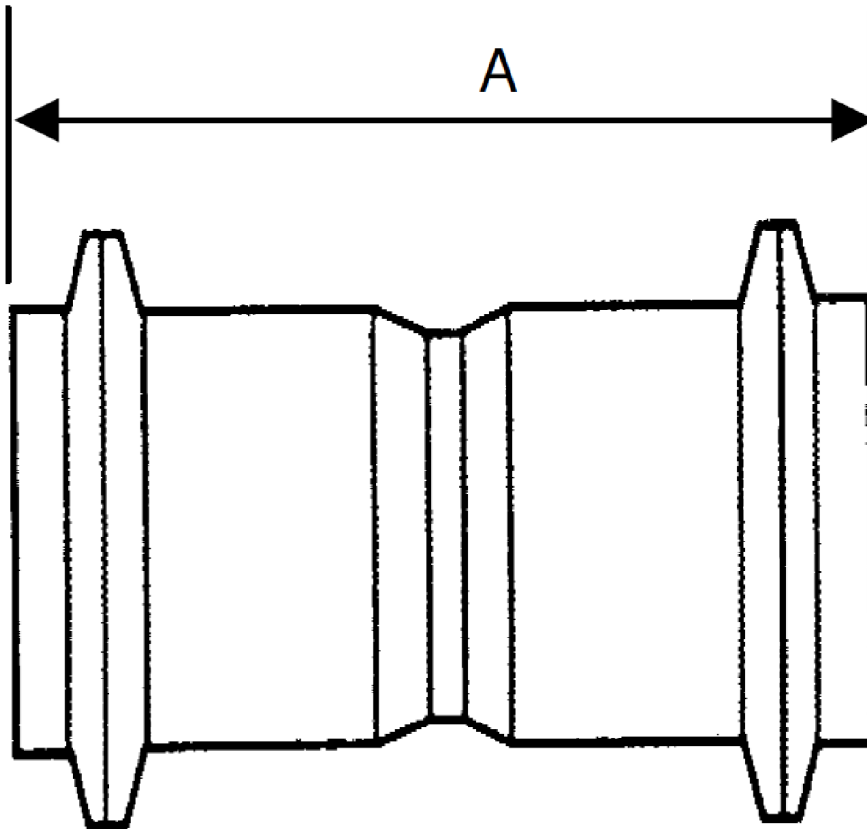

Size	A
10"	13.75
12"	15
15"	18.25
18"	21
21"	25.5
24"	27.75
27"	29.5
30"	45.5
36"	44.25
42"	46
48"	48.75

DISCLAIMER - PLEASE READ

- DIMENSIONS AND APPEARANCE ARE APPROXIMATE AND SUBJECT TO CHANGE WITHOUT NOTICE DUE TO DESIGN OR PRODUCTION MODIFICATIONS
- ANGLE TOLERANCE FOR ELBOWS IS +/- 2 DEGREES.
- ALL OTHER DIMENSIONS ARE TO TOLERANCES OF +/- 1"
- ALL FITTINGS ARE SUBJECT TO RBP "STANDARD TERMS AND CONDITIONS"

**36" STOP COUPLING
PVC SDR35 GASKETED SEWER
36" x 36" GxG**

 **ROYAL**[™] Building Products

royalbuildingproducts.com

56400 Mound Road, Shelby Township, MI 48316
Phone (800)232-5690 -- Fax (586)781-0888

PRINTED COPIES ARE FOR REFERENCE ONLY

DATE: 3/25/2015

DRAWN BY: RKS

DATE: 3/25/2015

CHECKED BY: RBP

L6036.S

CUSTOMER